

PAB-A Series
REGULATED DC POWER SUPPLIES
OPERATION MANUAL

PAB 18-1A	PAB 18-1.8A
PAB 18-3A	PAB32-1.2A
PAB32-2A	PAB 70-1A
PAB 110-0.6A	PAB 250-0.25A
PAB 350-0.1A	

Use of Operation Manual

- Please read through and understand this Operation Manual before operating the product. After reading, always keep the manual nearby so that you may refer to it as needed. When moving the product to another location, be sure to bring the manual as well.
- If you find any incorrectly arranged or missing pages in this manual, they will be replaced. If the manual it gets lost or soiled, a new Operation Manual can be purchased. In either case, please contact your Kikusui agent, and provide the "Kikusui Part No." given on this page.
- This manual has been prepared with the utmost care; however, if you have any questions, or note any errors or omissions, please contact your Kikusui agent.

This Operation Manual is applicable to the PAB-A Series employed PC board A-650.

Reproduction and reprinting of this product as well as this operation manual, whole or partially, without our permission is prohibited. Both unit specifications and manual contents are subject to change without notice.

Power Requirements of this Product

Power requirements of this product have been changed and the relevant sections of the Operation Manual should be revised accordingly. (Revision should be applied to items indicated by a check mark ✓.)

Input voltage

The input voltage of this product is _____ VAC,
and the voltage range is _____ to _____ VAC.
Use the product within this range only.

Input fuse

The rating of this product's input fuse is
_____ A, _____ VAC, and _____.

WARNING

- To avoid electrical shock, always disconnect the AC power cable or turn off the switch on the switchboard before attempting to check or replace the fuse.
- Use a fuse element having a shape, rating, and characteristics suitable for this product. The use of a fuse with a different rating or one that short circuits the fuse holder may result in fire, electric shock, or irreparable damage.

Power Requirements of this Product (cont'd)

AC power cable

The product is provided with AC power cables described below. If the cable has no power plug, attach a power plug or crimp-style terminals to the cable in accordance with the wire colors specified in the drawing.

WARNING

- The attachment of a power plug or crimp-style terminals must be carried out by qualified personnel.

Without a power plug

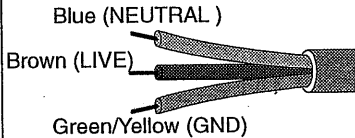

Without a power plug

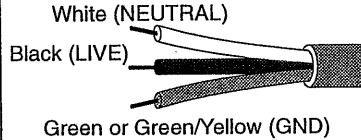

Plugs for USA

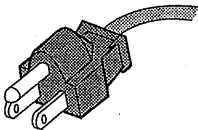

Plugs for Europe

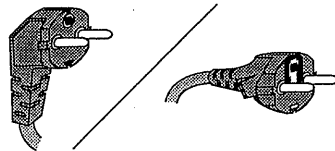

Provided by Kikusui agents

Kikusui agents can provide you with suitable AC power cable. For further information, contact your Kikusui agent.

TABLE OF CONTENTS

	<u>PAGE</u>
SECTION 1. GENERAL	1
1-1. Description	1
1-2. Specifications	3
* Mechanical Outline Drawing	8
SECTION 2. OPERATION	13
2-1. Precautions Before Use	13
2-2. Description of Panel Items	21
2-3. Operating Procedures	26
2-4. Modification of FINE Setting Potentiometer	31
2-5. Rack Mount	32
SECTION 3. APPLICATIONS	34
3-1. ON/OFF-control of Output	35
3-2. Remote Control of Constant-voltage Output	37
1. Control of Output Voltage With External Voltage	37
2. Control of Output Voltage With External Resistance I .	41
3. Control of Output Voltage With External Resistance II..	44
3-3 Remote Control of constant-current Operation	47
1. Control of Output Current With External Voltage	47
2. Control of Output Current With External Resistance I .	50
3. Control of Output Current With External Resistance II	53

	<u>PAGE</u>
3-4. Series or Parallel Operation	56
3-5. One-control Parallel Operation	58
3-6. One-control Series Operation	61
3-7. External Battery Drive of Digital Meter	65
SECTION 4. MAINTENANCE	67
4-1. Inspection	67
4-2. Adjustment and Meter Calibration	70
* Schematic Diagram	

SECTION 1. GENERAL

1-1. Description

The PAB-A Regulated DC Power Supply is an automatic constant-voltage/constant-current transfer type of power supply with an auto-range display meter (3-1/2 digits, liquid crystal display).

The output voltage and output current can be displayed by selecting them with the switch on the front panel. An external voltage also can be displayed with the meter as an input terminal for such signal is provided on the front panel (except the PAB250-0.25A and PAB350-0.1A which have no external voltage measuring function).

The control circuit is a monolithic IC based circuit. It employs a temperature compensation type of reference diode, metal film resistors of excellent temperature coefficient, and wire wound potentiometers, thereby realizing stable output characteristics.

The output switch is an electronic switch which causes no chattering or other noise and which can be electronically remote-controlled. When the output switch is off, the output voltmeter indicates the value corresponding to the voltage setting knob, facilitating the voltage preset operation.

The FINE VOLTAGE setting control can be changed to that for current setting control by changing the internal connector setting. The PAB110-0.6A, PAB250-0.25A and PAB350-0.1A have no FINE VOLTAGE setting control.

The operation mode is clearly identified between the CV mode (constant-voltage mode) and the CC mode (constant-current mode) with the LEDs on the front panel.

In order to be usable as a system component of an automation system, the PAB-A Series Power Supply has on its rear panel the remote-control terminals for control of the output voltage or output current with an external control voltage signal. The full-scale adjustment can be accomplished from the front panel. The remote/local selector switch,

which is convenient for adjustment and maintenance of the power supply when it is used as a system component of an automation system, is provided underneath the output terminals (binding post terminals).

In order that the power supply is usable as a fixed power supply component of an equipment as well as for laboratory use, guard caps for fixing or semi-fixing the control potentiometers are supplied. The power supply is incorporated with a potentiometer burn-out protection feature.

Please be sure to thoroughly read this instruction manual before starting operating the power supply.

1-2. Specifications

Model	PAB 18-1A	PAB 18-3A	PAB 32-1.2A	PAB 32-2A	PAB 70-1A	PAB 110-0.6A	PAB 250-0.25A	PAB 350-0.1A
Input								
Input Voltage	120 VAC $\pm 10\%$, 50/60 Hz, single phase							
Power Consumption, 120 VAC, Rated Load	Approx. 50 VA	Approx. 85 VA	Approx. 130 VA	Approx. 85 VA	Approx. 150 VA	Approx. 146 VA	Approx. 136 VA	Approx. 75 VA
Output								
Output Voltage	0 - 18 V		0 - 32 V		0 - 70 V		0 - 250 V	
Voltage Resolution (Theoretical Value)	2.5 mV		4.5 mV		10 mV		20 mV	
No. of Turns of Output Voltage Setting Potentiometer	1 turn		10 turns					
Output Current (1 turn)	0 - 1 A	0 - 1.8 A	0 - 3 A	0 - 12 A	0 - 2 A	0 - 1 A	0 - 0.5 A	0 - 0.1 A
Output Current Resolution (Theoretical Value)	1.5 mA	2.7 mA	4.5 mA	1.8 mA	3 mA	1.5 mA	0.9 mA	0.15 mA
Constant-voltage Characteristics								
Regulation								
Source Effect (Line Regulation for $\pm 10\%$ Change of Line Voltage)	1 mV				5 mV		7 mV	
Load Effect (Load Regulation for 0 to 100% Change of Output Current)	2 mV				5 mV		7 mV	
Ripples and Noise (5 Hz - 1 MHz)	500 μ V				1 mV		2 mV	
							3 mV	
							5 mV	

(Continued)

Model	PAB 18-1A	PAB 18-1.8A	PAB 18-3A	PAB 32-1.2A	PAB 32-2A	PAB 70-1A	PAB 110-0.6A	PAB 250-0.25A	PAB 350-0.1A
Transient Response (5 - 100%) (Typical) *3	500 µsec								
Temperature Coefficient (Typical)	100 ppm/°C								
Remote Control (Control Voltage to Output Voltage Ratio)	Approx. 10V/18V	Approx. 10V/18V	Approx. 10V/32V	Approx. 10V/32V	Approx. 10V/70V	Approx. 10V/110V	Approx. 10V/250V	Approx. 10V/350V	
Remote Control (Control Resistance to Output Voltage Ratio)	Approx. 10kΩ/18V	Approx. 10kΩ/18V	Approx. 10kΩ/32V	Approx. 10kΩ/32V	Approx. 10kΩ/70V	Approx. 10kΩ/110V	Approx. 10kΩ/250V	Approx. 10kΩ/350V	
Constant-current Characteristics									
Regulation									
Source Effect (Line Regulation for ±10% Change of Line Voltage)	2 mA			5 mA			1 mA		
Load Effect (Load Regulation for 0 to 100% Change of Output Voltage)	10 mA			5 mA			3 mA		
Ripple and Noise (5 - 1 MHz) (rms) *2	1 mA								
Remote Control (Control Voltage to Output Current Ratio)	Approx. 10V/1A	Approx. 10V/1.8A	Approx. 10V/3A	Approx. 10V/1.2A	Approx. 10V/2A	Approx. 10V/1A	Approx. 10V/0.6A	Approx. 10V/0.25A	Approx. 10V/0.1A
Remote Control (Control Resistance to Output Current Ratio)	Approx. 10kΩ/1A	Approx. 10kΩ/1.8A	Approx. 10kΩ/3A	Approx. 10kΩ/1.2A	Approx. 10kΩ/2A	Approx. 10kΩ/1A	Approx. 10kΩ/0.6A	Approx. 10kΩ/0.25A	Approx. 10kΩ/0.1A
Constant-voltage Mode Indication	Indicated with CV lamp (green LED)								
Constant-current Mode Indication	Indicated with CC lamp (red LED)								
Operating Ambient Temperature Range	0 to 40 deg C (32 to 104 deg F)								

(Continued)

Model	PAB 18-1A	PAB 18-1.8A	PAB 18-3A	PAB 32-1.2A	PAB 32-2A	PAB 70-1A	PAB 110-0.6A	PAB 250-0.25A	PAB 350-0.1A
Operating Ambient Humidity Range	10% to 80% RH (No forming of dew)								
Storage Temperature and Humidity Ranges	-10 to +60 deg C (14 to 140 deg F), Not higher than 70% RH *4 (No forming of dew)								
Cooling Method	Unforced air cooling								
Polarity of Output Voltage	Positive or negative grounded								
Voltage Rating with Respect to Ground	±250 VDC								±500 VDC
Insulation Resistances									
Between Chassis and Line	30 MΩ or over, with 500 VDC								*5
Between Chassis and Output Terminal	20 MΩ or over, with 500 VDC								*5
Meter Performance									
Measuring System	Double integration system								
Display and Sampling Rate	LCD (liquid crystal display), up to 1999, 0.5 sec/sample (2 samples/sec)								
Viewing Angles	50 - 80 degrees vertical, 30 degrees horizontal								
Maximum Allowable Application Voltage, Maximum Allowable Common-mode Voltage	200 VDC between HI and LO terminals, 100 VDC between LOW terminal and ground								
DC Voltmeter									
Range Selection	Fully automatic 4-range selection: 200 mVDC, 2 VDC, 20 VDC, 200 VDC FS								
Output Voltmeter Accuracy *6	±(0.5% of rdg + 2 dgt), at 23 ±5 deg C (73.4 ±9 deg F), 80% RH or less (No forming of dew)								

(Continued)

Model	PAB 18-1A	PAB 18-1.8A	PAB 18-3A	PAB 32-1.2A	PAB 32-2A	PAB 70-1A	PAB 110-0.5A	PAB 250-0.25A	PAB 350-0.1A
Output Voltmeter Input Resistance	200 mV range: 100 MΩ or over; 2 - 200 V ranges: 1 MΩ								
Output Voltmeter Accuracy	±(0.5% of rdg + 2 dgt), at 23 ±5 deg C (73.4 ±9 deg F), 80% RH or less (No dew)								
Ammeter									
Full Scale (Fixed Range)	1.000 A	1.800 A	3.00 A	1.200 A	2.00 A	1.000A	0.600 A	0.250 A	0.100 A
Output Current Accuracy *7	±1% rdg ±5 dgt	±1% rdg ±2 dgt	±1% rdg ±2 dgt	±1% rdg ±5 dgt	+1% rdg ±2 dgt	±1% rdg ±5 dgt	±1% rdg ±5 dgt	±1% rdg ±5 dgt	±1% rdg ±5 dgt
Temperature Coefficient	Add (±400 ppm of FS) per deg C to the above-mentioned accuracy (tolerance)								
Zero Drift	Not greater than 3 dgt, within 0 to 40 deg C (32 to 104 deg F)								
Protections									
Input Fuse (SB: Slow Blow Type)	1.5 A SB	2 A SB	3 A SB	2 A SB	3 A SB	3 A SB	3 A SB	3 A SB	2 A SB
Output Fuse	1.5 A	2 A	4 A	1.5 A	2.5 A	1.5 A	1 A	0.3 A	-
Thermal Fuse	Trips at 126 deg C (259 deg F), installed in power transformer								
Weight	Approx. 2.8 kg	Approx. 3.0 kg	Approx. 4.1 kg	Approx. 3.0 kg	Approx. 4.1 kg	Approx. 4.1 kg	Approx. 4.1 kg	Approx. 4.0 kg	Approx. 3 kg
Rack Mounting									
JIS Type (50 mm Rack)									
EIA Type (19 inch rack)									
External Dimensions *8	Type M	Type M	Type L	Type M	Type L	Type L	Type L	Type L	Type M

- *1: The resolution is theoretical value as calculated using the numbers of turns of windings. In practice, for the sake of allowance, use a value of 3 to 5 times of the theoretical value.
- *2: Measured with the positive or negative output line grounded.
- *3: Time required by the output voltage for recovering to within 0.05% + 10 mV after output current change from 5% to 100%.
- *4: The restriction imposed by liquid crystal display (LCD). Note that high temperature (40 to 60 deg C (104 to 140 deg F)) and high humidity adversely affect the longevity of LCD.
- *5: As measured in ambient humidity not higher than 70% RH.
- *6: With the output switch set in the ON state.
- *7: As measured after allowing a stabilization time of 30 minutes or more in the state that the output current is fed, at 23 ±5 deg C (73.4 ±9 deg F) and 80% RH or less.
- *8: External dimensions (Maximum dimensions)

Type M: 106 W × 140 H × 149 D mm (4.17 W × 5.51 H × 5.87 D in.)
 (111 W × 151 H × 189 D mm (4.37 W × 5.94 H × 7.44 D in.))

Type L: 106 W × 140 H × 209 D mm (4.17 W × 5.51 H × 8.23 D in.)
 (111 W × 151 H × 249 D mm (4.37 W × 5.94 H × 9.80 D in.))

Accessories

Model	Input Fuse (Spare)	Others	Instruction Manual
PAB18-1A	1.5 A, SB	Guard caps (1 set) Plugs (2) GND terminal (1) Seal (1 sheet) Connector (H)	1 copy
PAB18-1.8A	2 A, SB		
PAB18-3A	3 A, SB		
PAB32-1.2A	2 A, SB		
PAB32-2A	3A, SB		
PAB70-1A			
PAB110-0.6A			
PAB250-0.25A		Guard caps (1 set), GND terminal (1) Seal (1 sheet) Connector (H)	
PAB350-0.1A	2A, SB		

BRACKET B42 FOR RACK MOUNT (RMF-4)
(D# 411788)

2-φ4.5

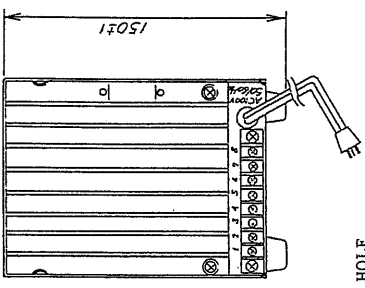
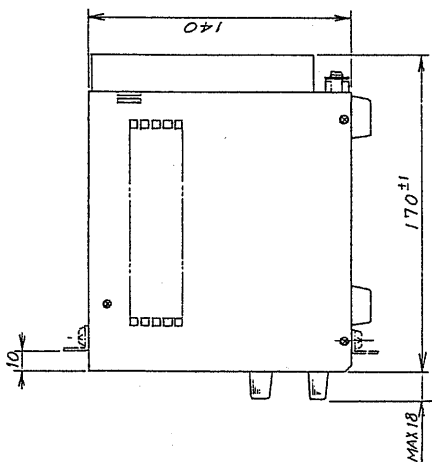
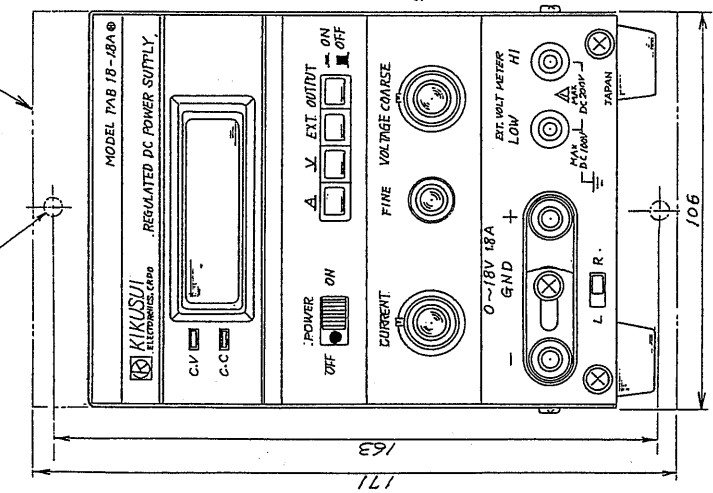

3-M3 MOUNTING HOLE

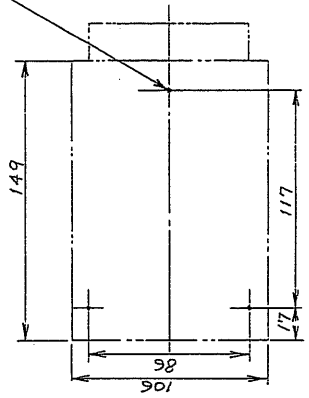

APPLICABLE MODELS
PAB 18-1A
PAB 18-1.8A
PAB 32-1.2A

THE FRONT PANEL IS THAT
OF PAB 18-1.8A.

TO DIRECTLY FIX THE POWER
SUPPLY TO THE CHASSIS.

Figure 1-1. Mechanical Outline Drawing of PAB (A) Series Power Supply, Type M

BRACKET B42 FOR RACK MOUNT (RMF-4)
(D# 411788)

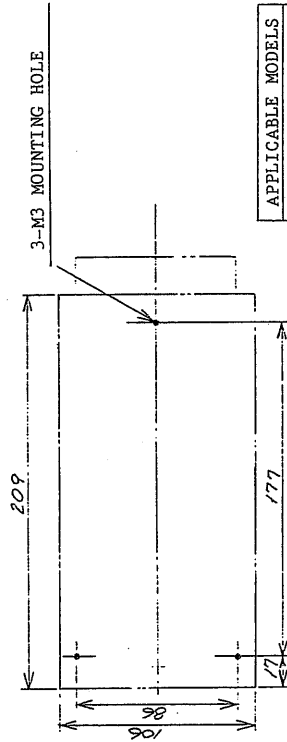
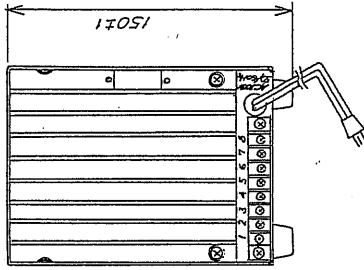
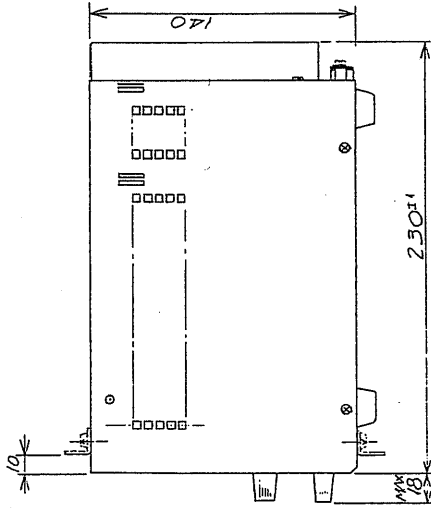
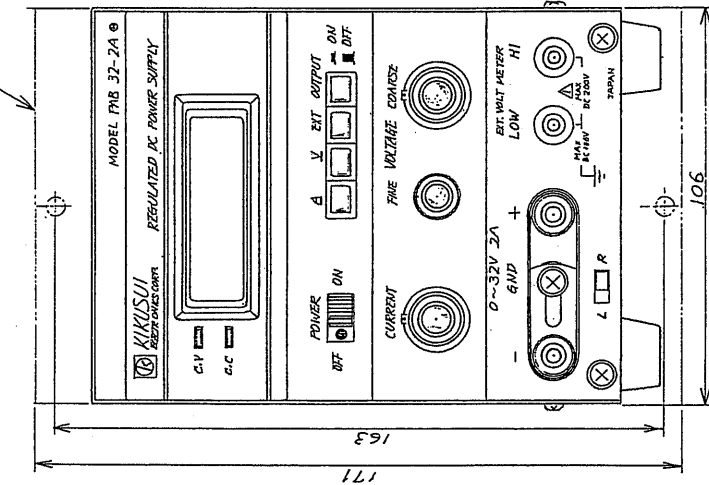

APPLICABLE MODELS
PAB 18-3A
PAB 32-2A
PAB 70-1A

TO DIRECTLY FIX THE POWER
SUPPLY TO THE CHASSIS.

THE FRONT PANEL IS THAT
OF PAB 32-2A.

Figure 1-2. Mechanical Outline Drawing of PAB (A) Series Power Supply, Type L

BRACKET B42 FOR RACK MOUNT (RMP-4)
(D# 411788)

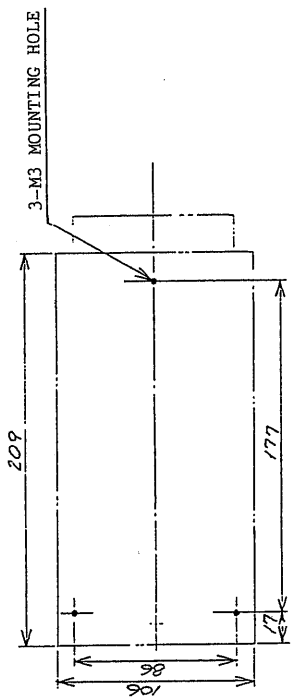
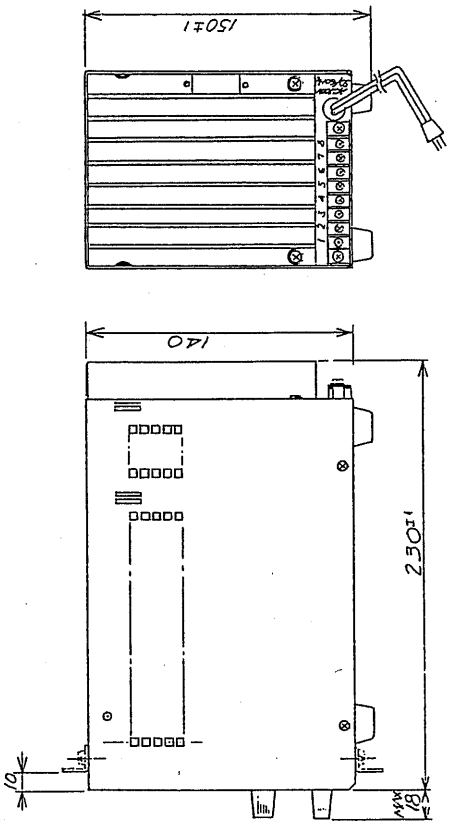
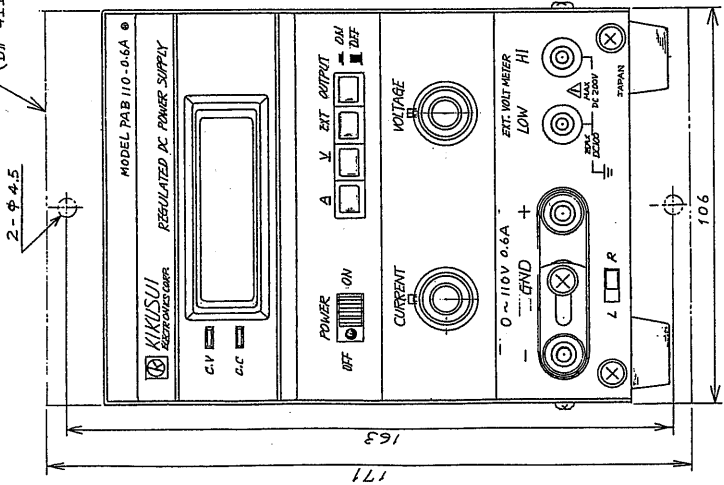

TO DIRECTLY FIX THE POWER
SUPPLY TO THE CHASSIS.

Figure 1-3. Mechanical Outline of PAB110-0.6A

BRACKET B42 FOR RACK MOUNT (RMF-4)
(D# 411788)

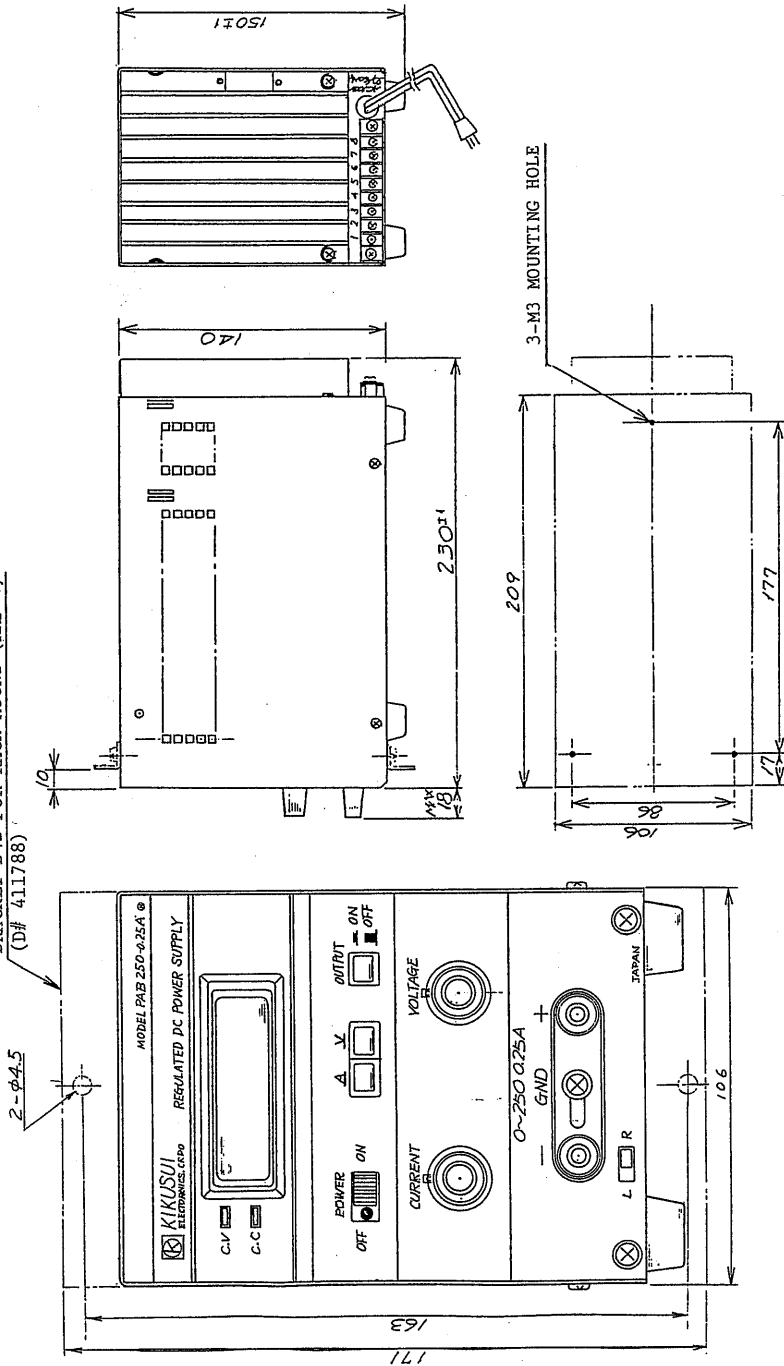

Figur 1-4. Mechanical Outline of PAB250-0.25A

BRACKET B42 FOR RACK MOUNT (RMF-4)
(D# 411788)

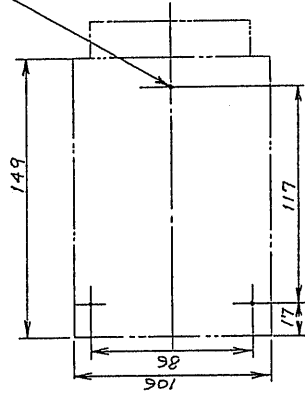
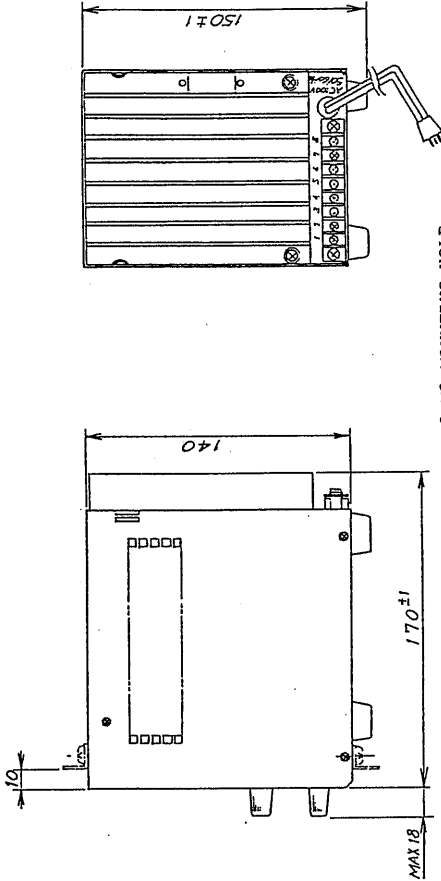
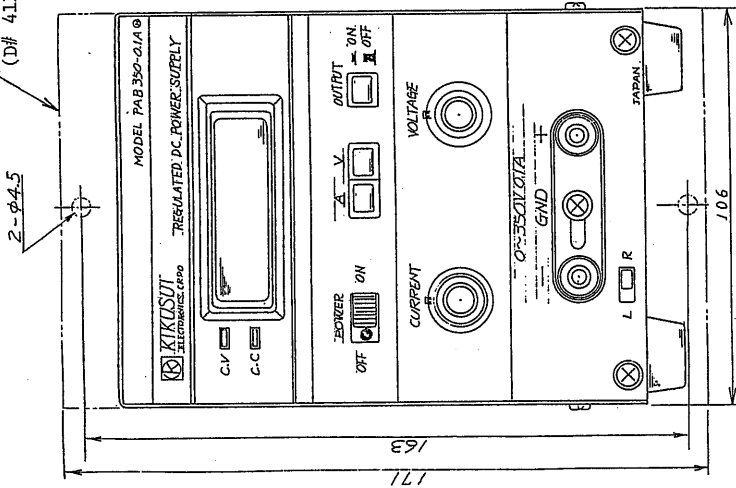

TO DIRECTLY FIX THE POWER
SUPPLY TO THE CHASSIS.

Figur 1-5. Mechanical Outline of PAB350-0.1A

SECTION 2. OPERATION

Inspection Upon Delivery:

When the instrument is delivered to you, immediately inspect it for any damage which might have been sustained when in transportation. If any sign of damage or malfunctioning is found, immediately notify the transportation company and/or your Kikusui agent.

Storage:

The conditions for storing the instrument is ambient temperature -10°C to 60°C (14°F to 140°F) and humidity not higher than 70% RH. These conditions are needed to protect the liquid crystal display. Note that the longevity of the liquid crystal display will be badly shortened if the instrument is stored in high temperature and high humidity.

2-1. Precautions Before Use

* NOTE: BE SURE TO NOTE THE FOLLOWING ITEMS BEFORE STARTING OPERATING THE INSTRUMENT.

(1) Input power

- o The input power requirements of the instrument are 108 - 132 V, 48 - 62 Hz single-phase AC. Be sure to operate the instrument with an input power within these ranges.

(2) Inrush current

- o When the power switch is turned on, the instrument may draw an inrush current of 20 - 30 A peak, with a half-amplitude period of approximately 5 msec. The cause of the inrush current is magnetic saturation of the power transformer. Theoretically, if the power switch is turned on with such timing that the phase angle with respect to the AC line voltage waveform is zero (zero crossing), the transformer core is saturated and its impedance becomes close to that of an air-core coil and a large inrush

current flows. If the power switch is turned on with a timing of 90-degree of phase angle, no transient current (inrush current) flows. Other factors which affect the inrush current are the polarity of the remaining magnetic flux of the core, line impedance, and line voltage.

- o Pay attention to the inrush current especially when a larger number of instruments are turned on at the same time.
- o For the input power fuse, use an SB (slow blow) or a time lag type of fuse.

(3) Terminal block

- o Check that the jumper of the rear terminal block is correctly set. When in the standard operation, the jumper should be connected between terminals ⑥ and ⑦.

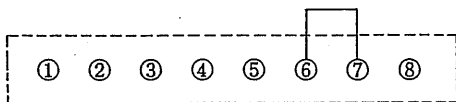

(4) Binding post terminals

- o For the GND terminal, a screw-type terminal is used for convenience of wire connection. It has a terminal post for output wire connection with a pair-plug.
- o Normally, connect the negative or positive output terminal to the GND terminal using the shorting bar.

(5) Digital display

- o The least-significant one or two digits of the display may flicker. The cause of this is not the ripple noise of the output. It is due to the performance of the A/D converter.
- o When large common-mode noise is superimposed on the AC line voltage or when there is a powerful noise source near the instrument, the digital display may be driven with an external battery power source (1.5 V × 2) to stabilize the indication. (See Section 3-7.)

- o The viewing angles of the liquid crystal display of the instrument which is for bench-top use are as illustrated below.

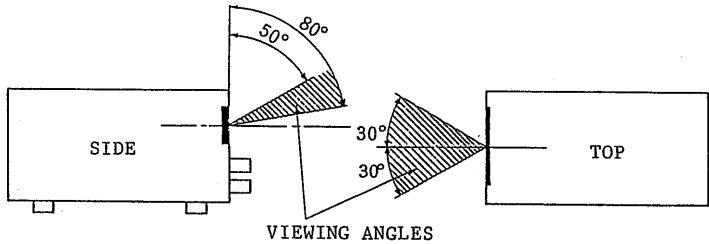

- o The longevity of the liquid crystal display is approximately 5 years. When contrast degradation, indication failure, or other signs of deterioration of the display is found, order your Kikusui agent for replacement of the display.

(6) Voltmeter (EXT mode)

- o The maximum allowable voltage of the DC voltmeter is 200 V. Never apply any voltage higher than 200 V. (The PAB250-0.25 and PAB350-0.1A have no EXT mode.)

Note: Even when a voltage higher than 200 V is applied, the voltmeter will indicate the voltage as the instrument has an auto-range function. However, never apply such voltage because the maximum allowable voltage of the voltmeter is 200 V DC.

- o When measuring an external voltage with the voltmeter, the maximum allowable potential difference between the LOW terminal and the chassis (GND terminal) is 100 V DC.

Note: Note that the voltmeter must not be used to measure a voltage of a floating point which has more than 100 V DC of potential difference with respect to the chassis potential of the instrument.

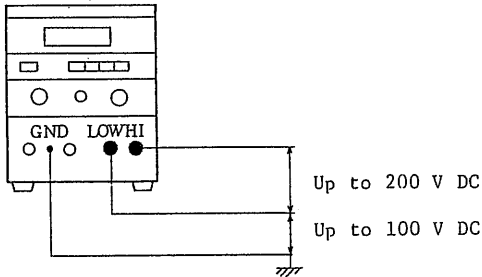

- o For the EXT mode to measure an external voltage, the auto-range digital voltmeter of the instrument is switched over to the external voltage measuring circuit by a switching circuit. Therefore, unlike the case of a dedicated voltmeter, some restrictions may be imposed on the measurable circuits. (For examples, when a voltage of a high impedance circuit is measured, restrictions may be imposed by line noise rejection ratio, capacitive coupling to the line, and induction noise.)
- (7) Installation
- o Do not stack up two or more instruments. (Since the instruments are of the unforced air cooling type, the upper instruments may become overheated due to convection.) When the output currents are suppressed to less than a half of the rated current, however, up to two units may be operated being stacked up.
 - o The heat sink at the rear of the instrument becomes hot (approximately 50°C (122°F) when the instrument is operated with the rated full load and input voltage 132 V AC). Pay attention to ventilation. Do not place near the heat sink any objects which are not resistant against heat.
 - o Do not use the instrument in an atmosphere which contains sulfuric acid mist or other substances which cause corrosion to metal. Install the instrument sufficiently apart from such chemical shop as plating shop or electrolytic synthesizing shop. (It is most recommendable to install the instrument in an airconditioned instrument room.)

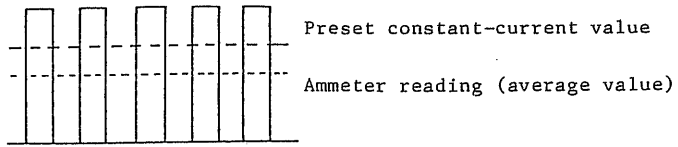

Figure 2-3. Load current of pulse waveform

In the above cases, the preset current value should be raised or the current rating should be increased.

(b) When the load is regenerative:

When a regenerative load (such as inverter, converter, or transformer) is connected to the power supply, as it cannot absorb the reverse current fed from the load, the output voltage increases and becomes unstable. In such a case, connect a bypass resistor as shown in Figure 2-4 to absorb the reverse current. The resistance of the bypass resistor can be calculated as follows:

$$R_D[\Omega] \leq \frac{E_o \text{ [V]}}{I_{RP} \text{ [A]}}$$

where, R_D : Dummy load (bypass resistor) to absorb reverse current

E_o : Output voltage

I_{RP} : Maximum reverse current

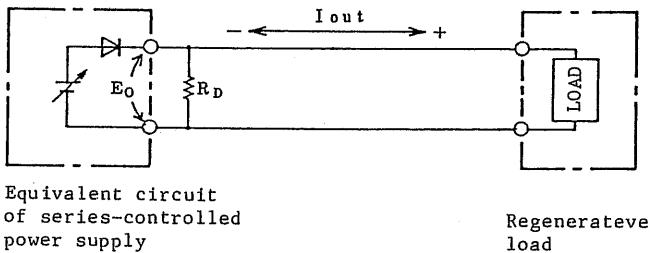

Figure 2-4

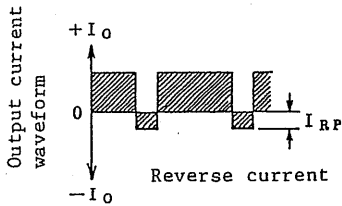

Figure 2-5

(10) Guard caps

With the guard caps (accessories), the voltage and current control potentiometers can be fixed or semi-fixed as shown in Figure 2-6. The guard caps may be used when installing the power supply as a permanent component of a system equipment or when using it as a fixed-output power supply.

Note: When the power supply is operated in the external voltage control mode, the potentiometers on the front panel are used as full-scale adjustment potentiometers. In this case, be sure to protect them with the guard caps.

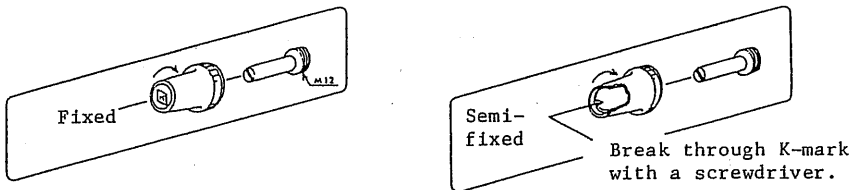
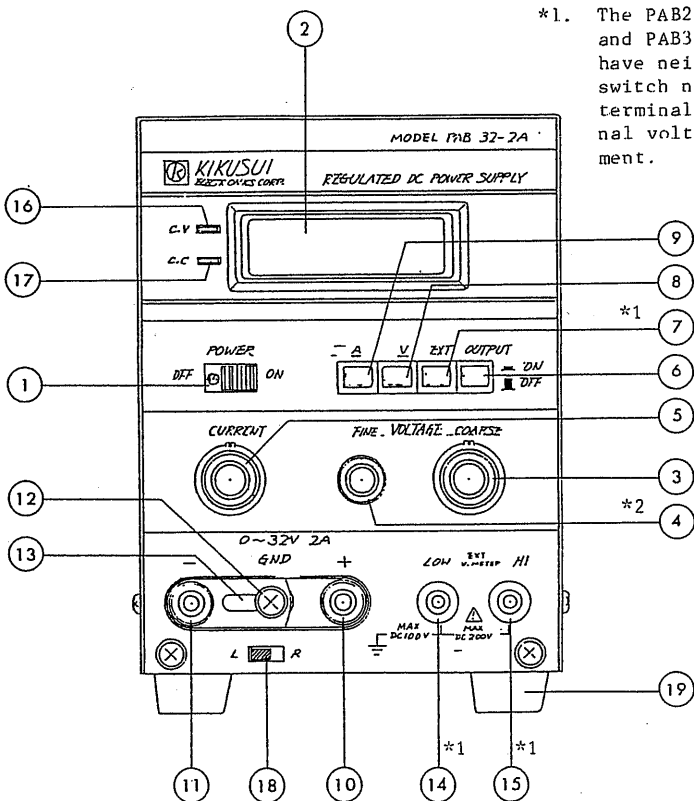
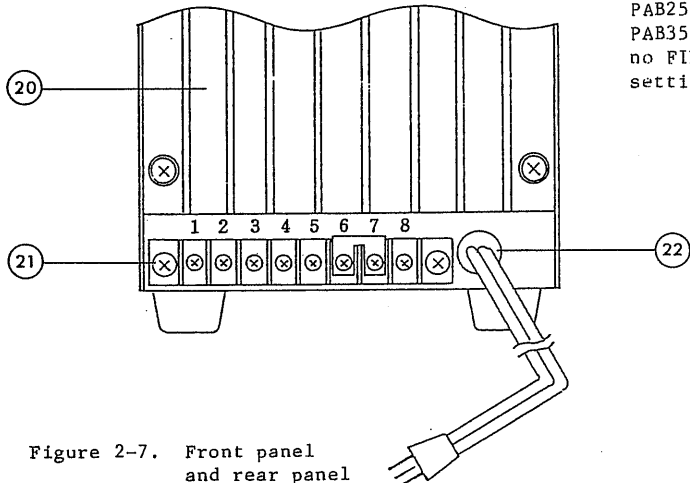

Figure 2-6

- (11) The PAB110-0.6A and PAB250-0.25A are incorporated with a shorting protector which reduces the output current to approximately 10% of the set output current for the PAB110-0.6A or to approximately 30% for the PAB250-0.25A when the output circuit is shorted. Due to this protective circuit, it takes about 3 seconds for the output voltage to reach the set value after the output current is set at a small value and the output circuit is changed from the shorted state to the open state.



*1. The PAB250-0.25A and PAB350-0.1A have neither select switch nor input terminal for external voltage measurement.



*2. The PAB110-0.6A, PAB250-0.25A and PAB350-0.1A have no FINE VOLTAGE setting control.

Figure 2-7. Front panel and rear panel

2-2. Description of Panel Items

① POWER switch

- o For on/off control of input power.

② Digital meter

- o This meter is a liquid crystal display of 3-1/2 digits. The item to be displayed is selectable with the A/V/EXT switches.

Note: The least-significant one or two digits of the display may flicker. The cause of this is not the ripple noise of the output. It is due to the performance of the A/D converter. (See Item (5) of Section 2-1.)

③ COARSE VOLTAGE setting potentiometer

- o 1-turn potentiometer to set the output voltage for constant-voltage operation. (The PAB110-0.6A, PAB250-0.25A and PAB350-0.1A have a 10-turn potentiometer.)
- o The instrument employs a potentiometer burn-out protection circuit. No problems occur even when the potentiometer is turned to the 0 V position with the instrument connected to such load as a battery.

④ FINE VOLTAGE setting potentiometer

- o 1-turn potentiometer, to cover approximately 5% of the output voltage for fine setting. (The PAB110-0.6A, PAB250-0.25A and PAB350-0.1A have no FINE VOLTAGE setting potentiometer.)

⑤ CURRENT setting potentiometer

- o 1-turn potentiometer to set the output current for the constant-current operation.

- o By modifying internal connections, the FINE VOLTAGE setting potentiometer of (4) can be changed into a FINE CURRENT setting potentiometer. (See Section 2-4.) (This change is unavailable for the PAB110-0.6A, PAB250-0.25A and PAB350-0.1A which have no FINE VOLTAGE setting potentiometer.)

(6) OUTPUT ON/OFF switch

- o When this switch is set to the ON state, the CV or CC mode lamp turns on and the output voltage or current is delivered. When it is set to the OFF state, the lamp is turned off and the output is cut off. Even when it is set to the OFF state, a negative voltage of approximately -450 mV appears across the output terminals, although the current capacity when in this state is only approximately 100 μ A.
- o The switch is of an electronic type. Unlike the mechanical switch, it does not generate chattering noise and it has an excellent longevity (10,000 repetitions or over).

Note: Since the switch is of the electronic type, the output circuit is electronically closed even when the switch is set to the OFF state.

- o If the switch is set to the OFF state when the digital meter is set in the voltage (V) mode, presetting of the output voltage can be done observing it on the digital meter.

(7) External voltage measurement switch: EXT

(The PAB250-0.25A and PAB350-0.1A have no external voltage measuring function.)

- o When this button is pressed, the digital meter indicates the external voltage applied through the external voltage input terminals, in an auto-range mode. In this case, the digital voltmeter is disconnected from the output circuit of the power supply.

- o The digital voltmeter can be operated on a battery power of two dry cells of Type SUM-3. (See Section 3-7.) Thus, the digital voltmeter can be used as a tester even when no AC line power is available.

⑧ Voltmeter switch: V

- o When the OUTPUT switch is ON, the digital meter indicates the output voltage in the auto-range mode. When the OUTPUT switch is OFF, it indicates the voltage set by the voltage setting potentiometers for the constant-voltage mode, thereby facilitating the voltage setting operation.

⑨ Ammeter switch: A

- o The digital meter indicates the output current in the fixed-range mode.

⑩ OUTPUT terminal ("+" terminal)

- o Red binding post terminal. (Connectable crimping terminal diameter is 6 mm.)

⑪ OUTPUT terminal ("- " terminal)

- o White binding post terminal. (Connectable crimping terminal diameter is 6 mm.)

⑫ GND terminal

- o This terminal is connected to the instrument chassis for frame grounding.
- o A terminal post is provided so that a pair-plug can be used.

⑬ GND shorting bar

- o Normally, connect the "+" or "-" OUTPUT terminal to the GND terminal with this shorting bar.

⑭ External voltage input terminal 'low': LOW

(The PAB250-0.25A and PAB350-0.1A do not have this terminal.)

- o The terminal for the low impedance side for external DC voltage measurement.
- o The digital meter is isolated from the power supply. The maximum allowable application voltage between the LOW terminal and the power supply chassis (GND terminal) is 100 V DC. (See Item (6) of Section 2-1.)

⑮ External voltage input terminal 'high': HI

(The PAB250-0.25A and PAB350-0.1A do not have this terminal.)

- o The terminal for the high impedance side for external DC voltage measurement.
- o The maximum allowable application voltage between the HI terminal and the LOW terminal is 200 V DC. (See Item (6) of Section 2-2.)

⑯ Constant-voltage mode indicator lamp: CV

- o Indicates that the instrument is operating in the constant-voltage mode. (See Section 2-3-1.)
- o The lamp goes off as you turn off the OUTPUT switch.

⑰ Constant-current mode indicator lamp: CC

- o Indicates that the instrument is operating in the constant-current mode. (See Section 2-3-3.)
- o The lamp goes off as you turn off the OUTPUT switch.

⑱ Remote/local selector switch: R/L

- o When this switch is set to the L (local) position, the instrument can be operated locally with its front panel controls.

- o When this switch is set to the R (remote) position, the instrument can be operated remotely with an external control voltage signal. (See Section 3-2-1 or 3-3-1.)

NOTE: NORMALLY, SET THIS SWITCH TO THE 'L' POSITION.

(IF IT IS SET TO THE 'R' POSITION, THE OUTPUT WILL BE ZERO UNLESS AN EXTERNAL CONTROL VOLTAGE SIGNAL IS APPLIED.)

①9 Rubber stud

②0 Heat sink

- o To radiate into the surrounding atmosphere the heat generated within the semiconductors.
- o The instrument is of an unforced air cooling by convection. Do not block the convection air flow surrounding the heat sink. The heat sink may become as hot as 50°C (122°F), depending on the conditions of use. Do not place near the heat sink any objects which are not resistant against heat.

②1 Terminal block (screws M3-6L)

- o Terminals for remote control of output voltage or current, remote ON/OFF control, one-control, and series or parallel operation. (For details, see Section 3.)

②2 AC input cable

- o Cable for AC input power. Approximately 2 meters (6.6 ft) long, cross section 0.7 mm².

2-3. Operating Procedures

- o The PAB-A Series Power Supply is an automatic constant-voltage/constant-current transfer type of instrument. The indicator lamps on the front panel indicates whether the instrument is in the constant-voltage mode (CV mode) or in the constant-current mode (CC mode).

2-3-1. Explanation of Constant-voltage Mode of Operation

The constant-voltage (CV) mode of operation is briefly explained in this section for those who are not familiar with constant-voltage power supplies.

The two factors which define the output of a power supply are voltage (unit: volt) and current (unit: ampere). The constant-voltage mode of operation is such that the output voltage is maintained constant regardless of load change.

Assume such power supply that, when the output voltage (E_o) is 10 V and the load (R_L) is 10Ω , the output current (I_o) is $I_o = E_o/R_L = 10V/10\Omega = 1 \text{ A}$; when the load is reduced to 1Ω , the current is increased to 10 A; and when the load is reduced to 0.1Ω , the current is increased to 100 A. Thus, the power supply will tend to maintain the output voltage at 10 V regardless of load change. Examples of this type of power supplies (power sources) are storage batteries and dry cells.

Actually, however, the maximum current which can be drawn from a power supply is limited by its current rating. In other cases, the maximum current which can be fed is limited by the nature of the load. (Of the PAB-A Series Power Supply, the output current limit can be preset at the required value with its constant-current (CC) setting potentiometer.) When the output current has reached the preset constant-current value, the output voltage decreases, the CV lamp goes off, and the CC lamp turns on. When in the constant-current mode of operation, the output current does not increase beyond the preset limit even when the load resistance is reduced to smaller values and finally the output terminals of the instrument are shorted in an extreme case.

Thus, the instrument is capable of automatic transfer from the constant-voltage mode to the constant-current mode to protect the load against overcurrent. This system is referred to as "automatic CV/CC crossover system."

In Figure 2-8, operating points within the operating domains are shown for respective load lines. When the output voltage (E_o) is 10 V and the limit current is 2 A, the operating point for no load is at point A, that for $R_L = 10 \Omega$ is at point B, and that for $R_L = 5 \Omega$ is at point C. If the load resistance is reduced further from 5Ω to 3.3Ω , the operating point moves from point C to point D and the instrument operation is changed from the constant-voltage domain into the constant-current domain. Point C at which the operation mode is transferred is called "crossover point."

When the load resistance (R_L) is 3.3Ω , the output voltage is $I_o \times R_L = 2 \text{ A} \times 3.3 \Omega = 6.6 \text{ V}$.

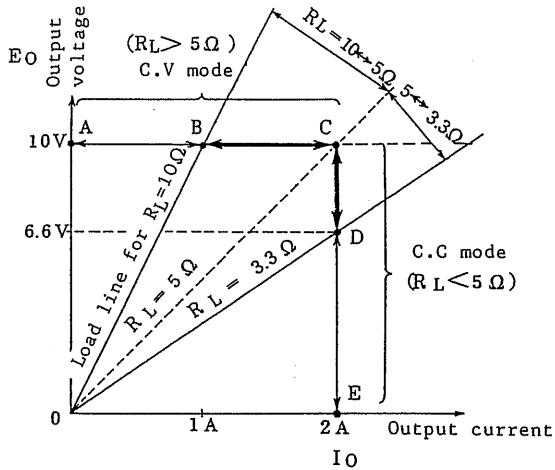

Figure 2-8

2-3-2. Operating Procedure for Constant-voltage Operation

- (1) Confirm that the OUTPUT switch is set in the OFF state. Turn on the POWER switch.
- (2) Turn on the V button of the digital meter selector. The digital meter will indicate the voltage set by the VOLTAGE setting potentiometers, although no output is delivered yet.

- (3) Adjust the voltage setting with the potentiometers as required.
- (4) Turn on the A button of the digital meter selector.
- (5) Short the OUTPUT terminals and turn on the OUTPUT switch so that the CC lamp (red) turns on.
- (6) Adjust the current setting with the CURRENT setting knob as required.
- (7) Turn off the OUTPUT switch, remove the shorting wire from between the output terminals, connect the load, and turn on the OUTPUT switch. The CV lamp (green) will turn on and the instrument will start operating in the constant-voltage mode. (If the CC lamp (red) turns on, raise the set current value or increase the current capacity in an appropriate means.)

Of the above steps, steps (1) through (3) are for output voltage setting and steps (4) through (6) are for current setting.

2-3-3. Explanation of Constant-current Mode of Operation

The constant-current (CC) mode of operation is briefly explained in this section for those who are not familiar with constant-current power supplies.

The two factors which define the output of a power supply are voltage (unit: volt) and current (unit: ampere). The constant-current mode of operation is such that the output current is maintained constant regardless of load change.

Assume such constant-current power supply that the output current of which is set at 2 A. When the load resistance (R_L) is 3.3Ω , the output voltage (E_o) will be $I_o \times R_L = 2 \text{ A} \times 3.3 \Omega = 6.6 \text{ V}$. When the load resistance is increased to 5Ω , the output voltage will be increased to 20 V; when the load resistance is increased to 10Ω , the output voltage will be increased to 20 V. Thus, the power supply will tend to maintain the output current at 2 A.

Actually, however, the maximum voltage of each power supply is limited by its voltage rating. (Of the PAB-A Series Power Supply, the output voltage limit can be preset at the required value with its constant-voltage (CV) setting potentiometer.)

In Figure 2-8, operating points within the operating domains are shown for respective load lines. When the output current is set at 2 A and the load resistance (R_L) is 3.3Ω , the operating point is point D. When the load resistance is increased to 5Ω , the operating point moves from point D to point C. When the resistance is increased further to 10Ω , the operating point moves from point C to point B where the instrument operation is transferred into the constant-voltage domain and the instrument no longer operates in the constant-current mode. When the load resistance is increased still more and ultimately it is made open, the operating point moves from point B to point A, in order that no voltage higher than the preset voltage (10 V) is applied to the load. Thus, the instrument operation is automatically transferred from the constant-current mode to the constant-voltage mode in order to protect the load. Point C where the instrument operation is transferred between the constant-current mode and the constant-voltage mode is referred to as "crossover point."

Many operators may not be familiar with constant-voltage or constant-current power supplies because such have hitherto been not very popular. Recently, however, they are rapidly becoming popular in the field of plating or other electrolytic processes where the amount of coulombs is needed to be controlled, in the field of solenoids where ampere-turns of coils are needed to be controlled, etc.

2-3-4. Operating Procedure for Constant-current Operation

- (1) Confirm that the OUTPUT switch is set in the OFF state. Turn on the POWER switch.
- (2) Turn on the V button of the digital meter selector. The digital meter will indicate the output voltage set by the VOLTAGE setting potentiometers, although no output is delivered.

- (3) Set with the VOLTAGE setting potentiometers the maximum voltage (limit voltage) which can be applied to the load.
- (4) Turn on the A button of the digital meter selector.
- (5) Turn the CURRENT setting potentiometer to the counterclockwise extreme position. Connect the load.
- (6) Turn on the OUTPUT switch. The CC lamp (red) will turn on.
- (7) Set the output current limit value as required, with the CURRENT setting potentiometer. The instrument will start operating in the constant-current mode, with its CC lamp turned on. (If the CV (green) lamp turns on, check for that the wiring for the load is not open and that the voltage setting is not too low.)

Of the above steps, step (1) through (3) are for output voltage setting and steps (4) through (7) are for current setting.

2-4. Modification of FINE Setting Potentiometer

o To modify the FINE VOLTAGE setting potentiometer into a FINE CURRENT setting potentiometer, proceed as shown in the following. (Except the PAB110-0.6A, PAB250-0.25A and PAB350-0.1A which have on FINE VOLTAGE setting potentiometer.)

- (1) Disconnect the power cord of the instrument. Remove the cover. (See Section 4-1-3.) Remove the clamping-screws of PC board A-650.
- (2) Pull out connector F of the PC board. Insert the connector in the reverse direction (invert between right and left).
- (3) Carefully fix (tighten lightly for tentative holding) the PC board with three screws. Turn on the POWER switch.
- (4) Turn the COARSE VOLTAGE setting potentiometer to the clockwise extreme position. Adjust potentiometer CV MAX on PC board A-650 so that the output voltage becomes the maximum voltage shown in Table 4-3 of Section 4-2-7.

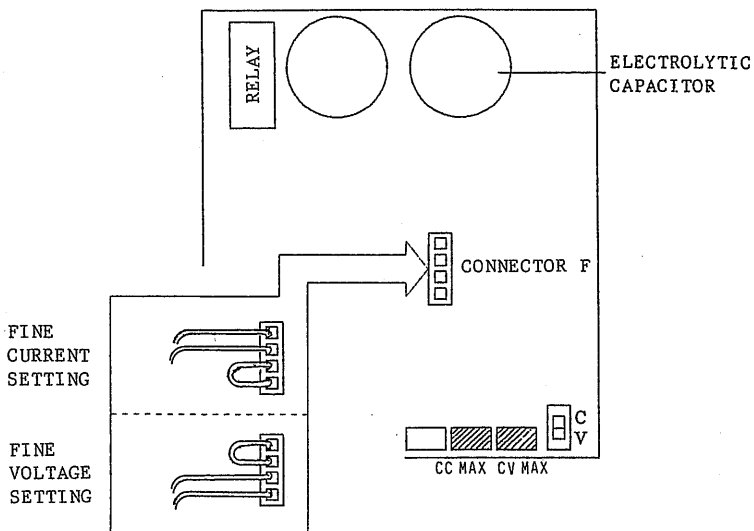

PCB A-650
LAYOUT OF COMPONENTS

- (5) Short the OUTPUT terminals. Turn both COARSE and FINE CURRENT setting potentiometers to the clockwise extreme position. Adjust potentiometer CC MAX on board A-650 so that the output current becomes the maximum current shown in Table 4-3 of Section 4-2-7.
- (6) Fix the PC board and install the cover.

2-5. Rack Mount

- o To install the instrument on a rack, the items shown in the following table are needed.

Type of rack	Rack mount frame	Bracket
50 mm rack (JIS type)	RMF4M	B42
19-inch rack (EIA type)	RMF4	B42

*: To install the instrument on a rack, four screws (M3-6L with washer, spring washer) are needed.

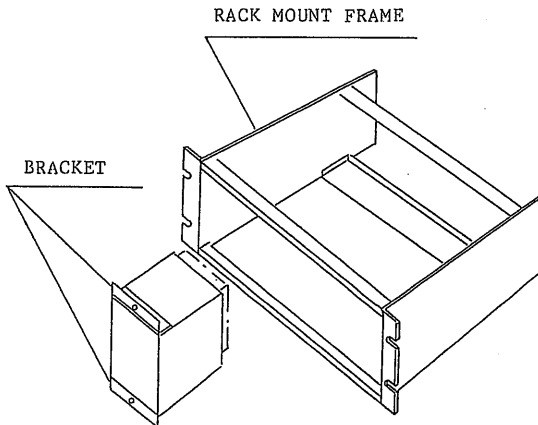

- o When installing two or more instruments on a rack, provide a separator board between them. (When installing two instruments directly stacked up, reduce their output currents to less than a half of their rated output because the instruments are of an unforced convection air cooling type.)
- o When installing a multiple number of instruments on a rack, provide a separator board between every two adjoining instruments and keep the temperature within the rack not higher than 30°C to 40°C (80°F to 104°F) using a fan motor or other appropriate means.

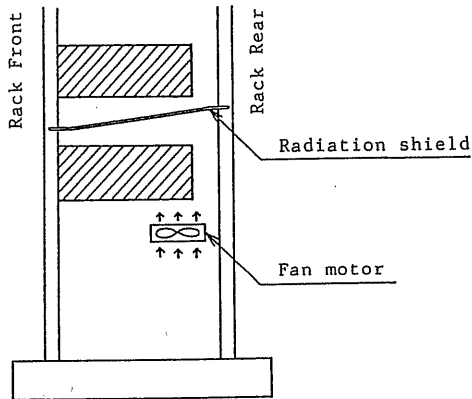

SECTION 3. APPLICATIONS

o Restrictions on Remote Control Operation

The relationships between the terminal numbers of the rear terminals and the application functions are as shown in Figure 3-1.

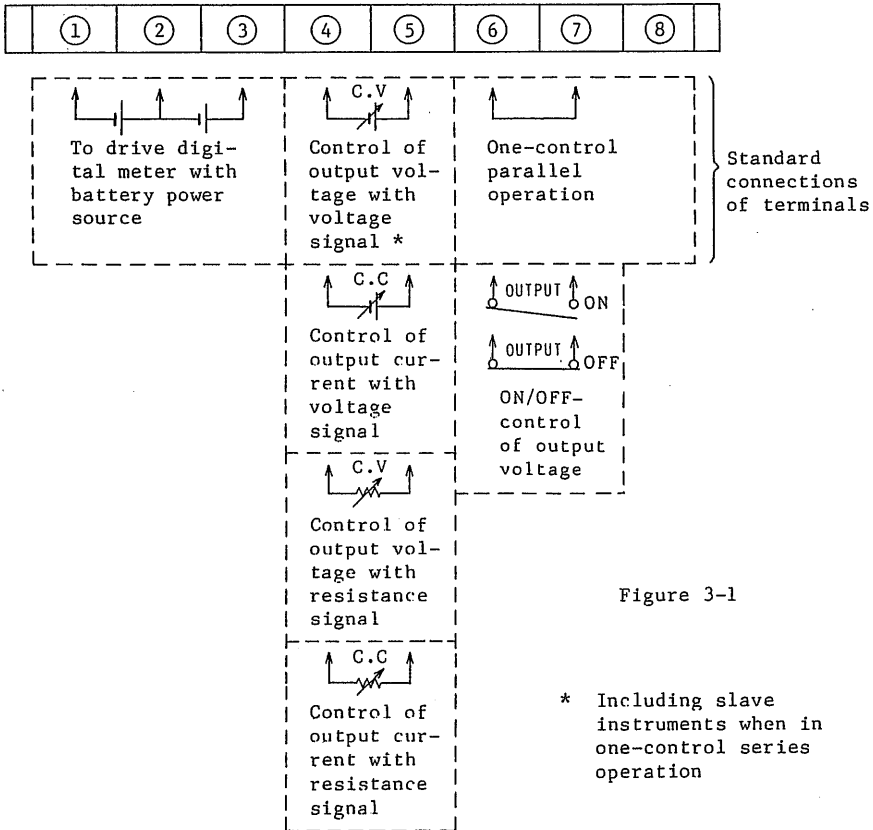

As can be seen in Figure 3-1, terminals ④ and ⑤ and terminals ⑥, ⑦ and ⑧ are used in common by changing the internal connectors on the PC board. Therefore, it is not possible to control the output voltage and current at the same time or to ON/OFF-control the output of the instruments which are in one-control parallel operation.

- o When the instrument is shipped from the factory, the standard connections of terminals are for battery drive of the digital meter, control of the output voltage with an external voltage signal, and one-control parallel operation.
- o Whenever connections of internal connectors are altered, be sure to clearly indicate the alterations by posting seals (supplied) on the terminal cover and casing of the instrument.

3-1. ON/OFF-control of Output

- o This operation is to remotely control with an external contact signal the ON/OFF operation of the instrument output.
- o For this operation, the internal connectors must be altered as required.

* Refer to "Restrictions on Remote Control Operation" of the preceding page.

- (1) Disconnect the input power cord from the input AC power line. Remove the cover referring to Section 4-1-3. Remove the clamping-screws of the PC board (A-650).
- (2) On PC board A-650, pull out connector D and insert it in connector position E. Do not forcefully pull out the connector as it is locked. To pull out the connector, see Figure 3-3.
- (3) Insert connector H (supplied) in connector position D.
- (4) Fix the PC board and the cover.
- (5) Post on the transparent cover above terminals ⑥ - ⑦ the following seal mark (supplied):

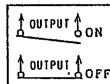

- (6) Post at a clearly visible position on the front panel or cover the following seal: REMOTE ON-OFF

- o The output is turned off when terminals ⑥ and ⑦ are shorted; it is turned on when the terminals are made open.
- o Keep the OUTPUT switch on the front panel in the ON state. The OFF state of the local switch or of the remote control signal has a priority over the ON state.

- Notes:
1. When in the ON/OFF-control operation through the rear terminal block, the CV/CC lamp does not go off.
 2. Since terminals ⑥ - ⑧ are used in common for one-control parallel operation also, be sure to post the seal to clearly indicate the alteration in order to guard against erroneous operation.

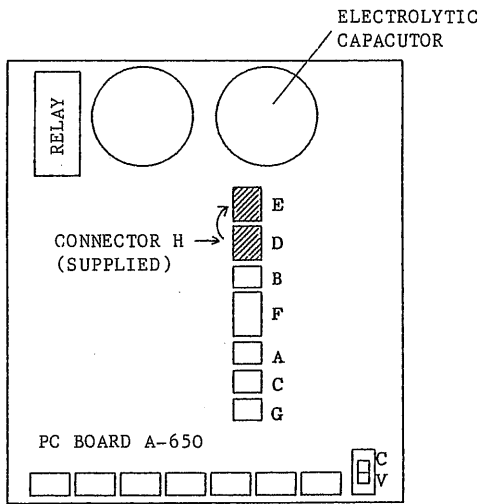

Figure 3-2. Layout of components

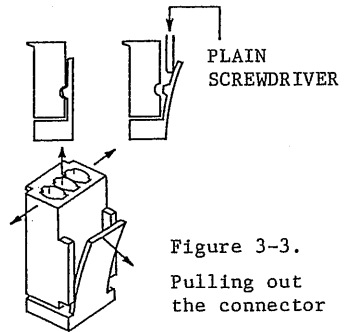

Figure 3-3. Pulling out the connector

Disengaging the lock with a screw driver, pull out the connector by lightly swaying it to right and left.

3-2. Remote Control of Constant-voltage Output

3-2-1. Control of Output Voltage With External Voltage

- o The output voltage can be controlled with an external voltage signal of 0 - 10 V.
 - o The common terminal for the external control signal is the "+" OUTPUT terminal.
 - o If the instrument has been set for the standard connections of terminals (standard connections of internal connectors A, B and C, and switch S), perform the following procedure starting by Step (5).
- * Read "Restrictions on Remote Control Operation" of Section 3.
- (1) Disconnect the input power cord. Remove the cover referring to Section 4-1-3. Remove the clamping-screws of the PCB (A-650).
 - (2) Change the connections of connectors A, B and C on PC board A-650 for the mating symbols. (See Figures 3-3, 3-5 and 3-8.)
 - (3) Throw switch S on PC board A-650 to the white mark side. (See Figure 3-5.)
 - (4) Carefully install the PC board.
 - (5) Connect the external control voltage signal (E1) to between terminals ④ and ⑤ of the rear terminal block, with terminal ⑤ for the positive polarity line.
 - (6) Throw the R/L (remote/local) selector switch to the R position.
 - (7) Remove the knobs of the COARSE and FINE VOLTAGE setting potentiometers and install the guard caps to make them a semi-fixed type so that they are protected against inadvertent change. (See section 2-1, (10).) (The PAB110-0.6A, PAB250-0.25A and PAB350-0.1A have no FINE VOLTAGE setting potentiometer. Provide a guard cap only for the COARSE VOLTAGE setting potentiometer.)

- (8) Turn on the POWER switch and the OUTPUT switch. Adjust the semi-fixed potentiometers on the front panel so that the output voltage for the 10 V of external control voltage signal becomes the required voltage.

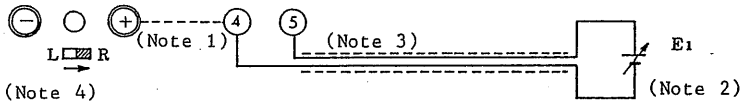

Figure 3-4

- o The relationships between output voltage (E_o) and external control voltage (E_1) is expressed as follows:

$$E_o = \frac{1}{10} \cdot E_{max} \cdot E_1 \cdot \alpha [V]$$

where, E_{max} : Maximum voltage rating [V]

E_1 : External control voltage signal [V]

$$0 \leq E_1 \leq 10 \text{ V}$$

- o Term α is a factor of 0 - 1, which depends on the VOLTAGE setting potentiometers. It is 1 when both COARSE and FINE VOLTAGE setting potentiometers are turned to the clockwise extreme position; it is 0 when both potentiometers are turned to the counterclockwise extreme position. It is used to select the ratio of the output voltage (E_o) with respect to the external control voltage signal (E_1). Normally, it is adjusted for the maximum voltage.

Note 1: The potential of the common line of the external control voltage signal (E_1) becomes that of the "+" OUTPUT terminal.

Note 2: The input impedance between terminals ④ and ⑤ is approximately 10 k Ω . The external control voltage signal should be with less ripple noise because the noise is amplified and conveyed to the output circuit.

- Note 3: To feed the external control voltage signal, use a shielded cable (or a pair of stranded wires) and connect the shielding wire to the "+" OUTPUT terminal. When the wiring distance is long, provide a full protection against noise.
- Note 4: When the R/L (remote/local) switch is thrown to the L position, the output voltage can be locally and manually controlled with the semi-fixed potentiometers on the front panel.
- Note 5: Make sure that the output voltage is within the rated output voltage of the instrument.
- Note 6: The output voltage (E_o) of the instrument is with a slight negative offset voltage (several tens to several hundreds millivolts) when the input voltage (E_i) is zero volts. If you need output voltage zero, apply a slight positive input voltage (several tens millivolts) to the instrument.

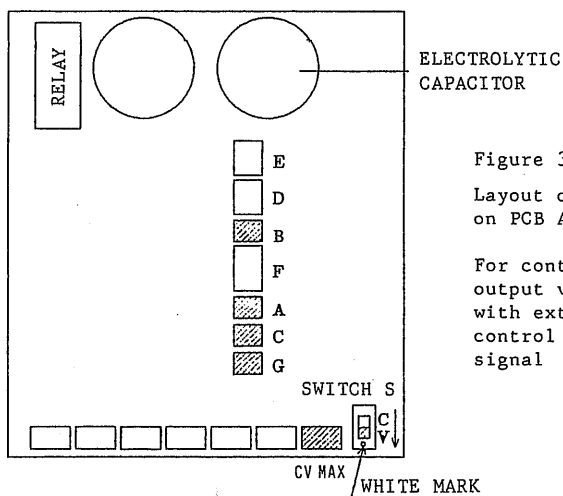
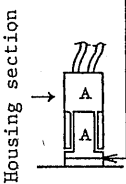

Figure 3-5.
Layout of components
on PCB A-650

For control of
output voltage
with external
control voltage
signal

o Relationships Between Application Functions and Connectors or Switches

Table 3-1



The diagram shows a cross-section of a connector housing. It is divided into two internal sections, both labeled 'A'. Wires are shown entering from the top. An arrow points to the left side of the housing, labeled 'Housing section'.

Connector on PC board		A	B	C	G	S (switch)
Housing section	Control of output voltage with external voltage signal	A	B	C	*	White mark side
	Control of output current with external voltage signal	A	B	C	*	No-mark side
	Control of output voltage with external resistance signal I	C	B	A	*	*
	Control of output voltage with external resistance signal II	A	B	G	C	White mark side
	Control of output current with external resistance signal I	A	C	B	*	*
	Control of output current with external resistance signal II	A	B	G	C	No-mark side

*: Not specified

3-2-2. Control of Output Voltage With External Resistance I

- o The output voltage can be controlled with an external resistance signal of 0 - 10 k Ω .

* Read "Restrictions on Remote Control Operation" of Section 3.

- (1) Disconnect the input power cord. Remove the cover referring to Section 4-1-3. Remove PC board A-650.
- (2) Change the connections of connectors A, B and C as shown in Figure 3-6. (See Figures 3-5 and 3-3.)

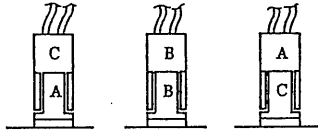

Figure 3-6

- (3) Connect external resistance signal R1 ($0 \leq R1 \leq 10 \text{ k}\Omega$) between terminals ④ and ⑤ of the rear terminal block.
- (4) Throw the R/L (remote/local) selector switch on the front panel to the L position.
- (5) Turn the FINE VOLTAGE setting potentiometer to the counter-clockwise extreme position. Remove the knob of the potentiometer and install the guard cap. (See Item (10) of Section 2-1.) (This procedure is not needed for the PAB110-0.6A, PAB250-0.25A and PAB350-0.1A which have no FINE VOLTAGE setting potentiometer.)
- (6) Exercising care so that the PC board is not contacted with the chassis, turn on the POWER switch and the OUTPUT switch.
- (7) The output voltage of the instrument is with a slight negative offset voltage (several tens to several hundreds millivolts) when the external resistance signal (R1) is zero.

- (8) Set the external resistance signal (R1) to 10 kΩ. Adjust potentiometer CV MAX on PC board A-650 so that the output voltage becomes the maximum rated voltage. This procedure is "full-scale adjustment." (See Figure 3-5.)
- (9) Carefully install the PC board and the cover.
- (10) Post the following seal on the transparent cover above terminals ④ and ⑤:

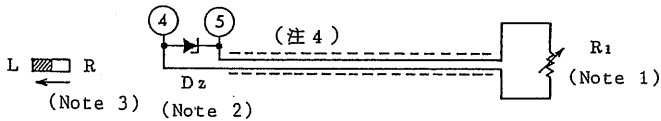

Figure 3-7

- o The relationships between the output voltage (Eo) and the external resistance signal (R1) are expressed as follows:

$$E_o = \frac{1}{10} \cdot R_1 \cdot E_{max} [V]$$

where, Emax: Maximum rated output voltage [V]

R1: External resistance signal [kΩ]

$$0 \leq R_1 \leq 10 [k\Omega]$$

- Note 1: o Note that an overvoltage will be produced in the output circuit if the external resistance signal (R1) circuit is made open. When changing resistances by selecting them with a switch, be sure to use a closed-circuit type of switch so that the circuit does not become open at any moment. If this requirement causes any undesirable effects, use the method of Section 3-2-3 "Control of Output Voltage With External Resistance Signal II."
- o The current which flows in the external control resistor (R1) is 1 mA, constantly. The maximum voltage is 10 V.

- o For the external control resistor (R1), use a resistor of 1/2 W or over, with good temperature, aging and noise characteristics.
- Note 2:
- o By connecting a zener diode Dz ($V_z = 11 \text{ V}$, 250 mW) between terminals (4) and (5) as shown in Figure 3-7, the output voltage can be limited at 110% of the rated voltage even when the external resistance circuit is made open.
 - o The leak current of the zener diode (Dz) causes poor linearity of the relationships between R1 and Eo. Use a zener diode which has less leak current.
- Note 3:
- o The R/L switch cannot be used when in this mode of operation. If the switch is thrown to the R (remote) position, no output is delivered. Keep it in the L (local) position.
- Note 4:
- o Note that the resistance of the wiring will cause an offset voltage.
 - o For wiring of the external resistance signal (R1), use a shielded cable (or a pair of stranded wires) and connect the shielding wire to the "+" OUTPUT terminal. When the wiring distance is long, pay attention to prevent induction noise.
- Note 5:
- o Pay attention so that the output voltage does not exceed the rated voltage.

3-2-3. Control of Output Voltage With External Resistance II

- o This operation is with a fail-safe feature such that the output voltage becomes zero volts when the external resistance signal circuit is made open (the resistance has become infinitive).
- * Read "Restrictions on Remote Control Operation" at the beginning of Section 3.

- (1) Disconnect the input power cord. Remove the cover referring to Section 4-1-3. Remove PC board A-650.
- (2) Change the connections of connectors C and G on PC board A-650 as shown in Figure 3-8. (Refer to Figures 3-5 and 3-3.)

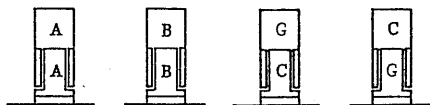

Figure 3-8

- (3) Connect the external resistance signal (R1) between terminals ④ and ⑤ of the rear terminal block.
- (4) Throw the R/L switch on the front panel to the L position.
- (5) Throw switch S to the white mark position. (See Figure 3-5.)
- (6) Turn the FINE VOLTAGE setting potentiometer to the counter-clockwise extreme position, remove its knob, and install the guard cap. (See Item (10) of Section 2-1.) (This procedure is not needed for the PAB110-0.6A, PAB250-0.25A and PAB350-0.1A which have no FINE VOLTAGE setting potentiometer.)
- (7) Paying attention so that the PC board is not contacted with the chassis, turn on the POWER switch and the OUTPUT switch.
- (8) Set the external resistance signal to zero and adjust potentiometer CV MAX on PC board A-650 so that the output voltage becomes the maximum rated voltage.

- (9) Carefully install the PC board and the cover.
- (10) Post the following seal on the transparent cover above terminals ④ and ⑤:

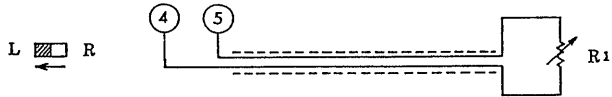
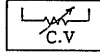

Figure 3-9

- o The relationships between the output voltage (E_o) and the external resistance signal (R_1) can be expressed as follows:

$$E_o = \frac{E_{ref} \cdot E_{max} \cdot b}{10 (a + R_1)}$$

where, E_{ref} : 6.5 [V]

E_{max} : 18V system 18 [V]

32V system 32 [V]

a: 6.5 [k Ω]

b: 0 - 10 [k Ω]

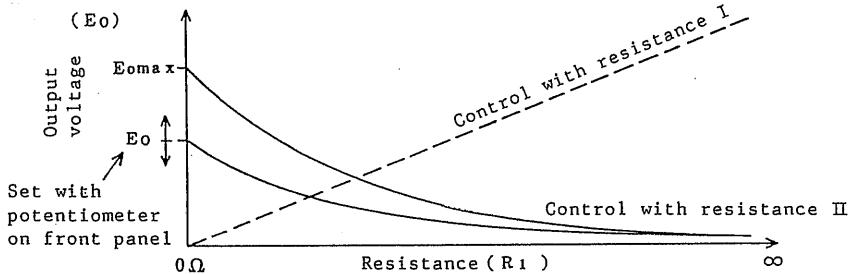

Figure 3-10

The output voltage (E_o) is inversely proportional to the external resistance signal (R_l) as shown in Figure 3-10. When the external resistance signal circuit is made open (the resistance has become infinite) due to switching of resistances or by inadvertent handling of the external resistance signal circuit, the output circuit is driven toward the safer side (the output voltage becomes zero volts).

The output voltage (E_o) is determined by R_l and b . Factor b is determined by the VOLTAGE setting potentiometers on the front panel.

Note 1: For the external resistance signal (R_l), use a resistor of 1/2 W or over, with good temperature, aging and noise characteristics.

Note 2: If the R/L switch is thrown to the R (remote) position, no output will be delivered. Keep it in the L (local) position.

Note 3: For wiring of the external resistance signal (R_l), use a shielded cable (or a pair of stranded wires) and connect the shielding wire to the "+" OUTPUT terminal. When the wiring distance is long, pay attention to prevent induction noise because such will be superimposed as ripple noise on the output.

3-3. Remote Control of Constant-current Operation

3-3-1. Control of Output Current With External Voltage

- o The output current can be controlled with an external control voltage signal of 0 - 10 V.
 - o For the common line of the external control voltage signal, use the "+" OUTPUT line.
 - * Read "Restrictions on Remote Control Operation" at the beginning of Section 3.
- (1) Disconnect the input power cord. Remove the cover referring to Section 4-1-3. Remove PC board A-650.
 - (2) Connect the connectors A, B and C on PC board A-650 for the mating symbols as shown in Figure 3-11. (See Figures 3-10 and 3-3.)

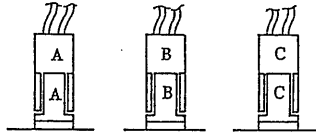

Figure 3-11

- (3) Throw switch S on PC board A-650 to the opposite position of the white mark position.
- (4) Carefully install the PC board and the cover.
- (5) Apply the external control voltage signal to between terminals ④ and ⑤ of the rear terminal block, with terminal ⑤ for the positive polarity line.
- (6) Throw the R/L switch on the front panel to the R (remote) position.
- (7) Remove the knob of the CURRENT setting potentiometer and install the guard cap to make the potentiometer a semi-fixed type. (See Item (10) of Section 2-1.)

(8) Turn on the POWER switch and the OUTPUT switch. Short the output terminal and adjust the semi-fixed potentiometer on the front panel so that the required output current is obtained when E2 is 10 V.

(9) Post the following seal on the transparent cover above terminals ④ and ⑤:

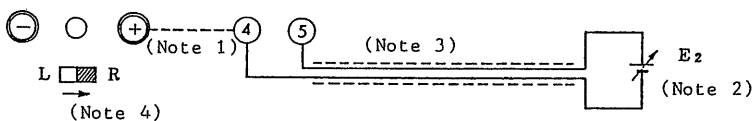

Figure 3-12

o The relationships between the output current (I_o) and the external control voltage signal (E_2) are expressed as follows:

$$I_o = \frac{1}{10} \cdot I_{max} \cdot E_2 \cdot \beta \text{ [A]}$$

where, I_{max} : Maximum rated current [A]

E_2 : External control voltage [V]

$$0 \leq E_2 \leq 10 \text{ [V]}$$

o Term β is a factor which is determined by the CURRENT setting potentiometer, for a range of 0 - 1. When the CURRENT setting potentiometer (including the FINE CURRENT setting potentiometer if the FINE VOLTAGE potentiometer has been modified to it) is turned to the clockwise extreme position, β is 1; when it is turned to the counterclockwise extreme position, β is 0. With this factor, the ratio of the output current (I_o) with respect to the external control voltage signal (E_2) can be adjusted.

Note 1: The potential of the common line of the external control voltage signal (E_2) becomes that of the "+" OUTPUT terminal.

- Note 2: The input impedance between terminals ④ and ⑤ is approximately 10 k Ω . Since the ripple noise component of the external control voltage signal is amplified and superimposed on the output voltage, use a voltage with less ripple noise for the signal.
- Note 3: For wiring of the external control voltage signal, use a shielded cable (or a pair of stranded wires) and connect the shielding wire of the cable to the "+" OUTPUT terminal. When the wiring distance is long, pay attention to induction noise.
- Note 4: By throwing the R/L switch to the L (local) position, the output current can be controlled manually (locally) with the semi-fixed potentiometer on the front panel.
- Note 5: Pay attention so that the output current does not exceed the rated current.

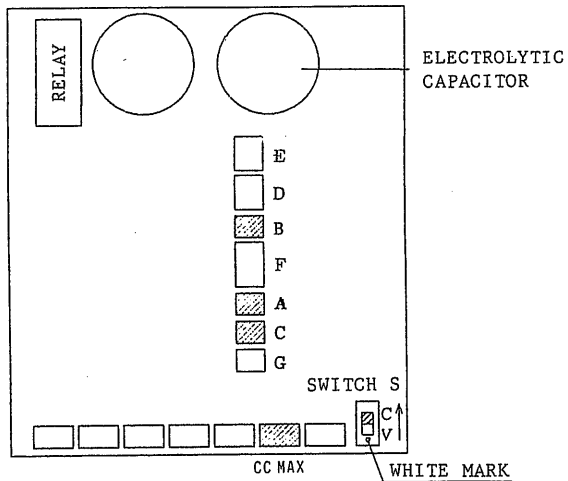

Figure 3-13. Layout of components on PCB A-650

Control of output current with external voltage signal

3-3-2. Control of Output Current With External Resistance I

- o The output current can be controlled with an external resistance signal of 0 - 10 k Ω .

* Read "Restrictions on Remote Control Operation" of Section 3.

- (1) Disconnect the input power cord. Remove the cover referring to Section 4-1-3. Remove PC board A-650.
- (2) Change the connections of connectors A, B and C on PC board A-650 as shown in Figure 3-14. (See Figures 3-10 and 3-3.)

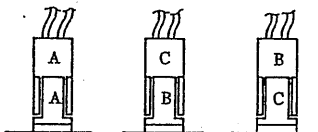

Figure 3-14

- (3) Connect the external resistance signal (R_2) between terminals ④ - ⑤. ($0 \leq R_2 \leq 10 \text{ k}\Omega$)
- (4) Throw the R/L switch to the L (local) position.
- (5) If the FINE VOLTAGE setting potentiometer has been modified for current setting, turn the potentiometer to the counterclockwise extreme position, remove its knob, and install the guard cap. (See Item (10) of Section 2-1.) (This procedure is not needed for the PAB110-0.6A, PAB250-0.25A and PAB350-0.1A which have no FINE VOLTAGE setting potentiometer.)
- (6) Paying attention so that the PC board is not contacted with the chassis, turn on the POWER switch and the OUTPUT switch.
- (7) Set R_2 at 10 k Ω . Adjust potentiometer CC MAX on PC board A-650 so that the output current becomes the maximum rated current. This procedure is for full-scale adjustment. (See Figure 3-10.)
- (8) Carefully install the PC board and the cover.

(9) Post the following seal on the transparent cover above terminals ④ and ⑤:

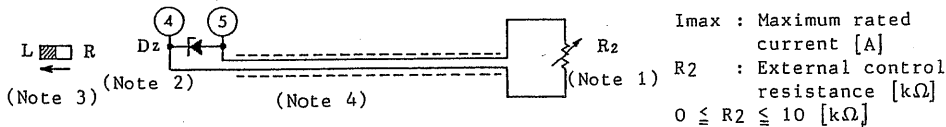

Figure 3-15

o The relationships between the output current (I_o) and the input resistance (R_2) are expressed as follows:

$$I_o = \frac{1}{10} \cdot R_2 \cdot I_{max} \text{ [A]}$$

where, I_{max} : Maximum rated current [A]

R_2 : External resistance signal [k Ω]

$$0 \leq R_2 \leq 10 \text{ [k}\Omega\text{]}$$

- Note 1:
- o The current which flows in the external resistance signal circuit is 1 mA constantly. The maximum voltage is 10 V.
 - o For the external resistance signal (R_2), use a resistor of 1/2 W or over, with good temperature, aging and noise characteristics.
 - o Note that an overcurrent may flow and the instrument may be damaged if the external resistance signal circuits is made open.
 - o Note that overshoots of the output current will be caused if the external resistance signal circuit is instantaneously made open when selecting resistances with a switch. To prevent such overshoots, use a short-circuit type of switch.
- Note 2:
- o By connecting zener diode Dz ($V_z = 11$ V, 250 mW) between terminals ④ and ⑤ as shown in Figure 3-12, the output current can be limited at approximately 110% of the rated current even when the external resistance signal circuit

is made open. The leak current of the zener diode will cause degradation of linearity of relationships between R_2 and I_o . Use a diode which has less leak current.

- Note 3: o The R/L switch should not be thrown to the R (remote) position. If it is thrown to the R position, no output is delivered. Keep the switch in the L (local) position.
- Note 4: o Note that the resistance of the wiring cable for the external resistance signal also is included in the external resistance signal.
- o Connect the shielding wire of the wiring cable to the "+" OUTPUT terminal.
 - o When the wiring distance is long, pay attention to induction noise.
- Note 5: o Pay attention so that the output current does not become higher than the rated current.

3-3-3. Control of Output Current With External Resistance II

o This operation is of a fail-safe type such that the output current becomes zero when the external resistance circuit is made open (when the resistance has become infinitive).

* Read "Restrictions on Remote Control Operation" of Section 3.

- (1) Disconnect the input power cord. Remove the cover referring to Section 4-1-3. Remove PC board A-650.
- (2) Change the connections of connectors C and H on PC board A-650 as shown in Figure 3-16. (See Figures 3-5 and 3-3.)

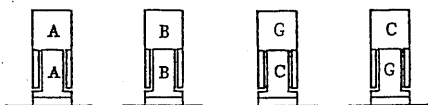

Figure 3-16

- (3) Connect the external resistance signal (R2) between terminals ④ and ⑤ of the rear terminal block.
- (4) Throw the R/L switch on the front panel to the L position.
- (5) Throw switch to the white mark side. (See Figure 3-5.)
(This procedure is not needed for the PAB110-0.6A, PAB250-0.25A and PAB350-0.1A which have no FINE VOLTAGE setting potentiometer.)
- (6) If the FINE VOLTAGE setting potentiometer has been modified for current setting, turn the potentiometer to the counterclockwise extreme position, remove its knob, and install the guard cap so that the potentiometer becomes a semi-fixed type. (See Item 10 of Section 2-1.)
- (7) Exercising care so that the PC board is not contacted with the chassis, turn on the POWER switch and OUTPUT switch.

- (8) Set the external resistance signal (R2) at zero. Adjust potentiometer CC MAX on PC board A-650 so that the output voltage becomes the maximum rated voltage.
- (9) Carefully install the PC board and the cover.
- (10) Post the following seal on the transparent cover above terminals ④ and ⑤:

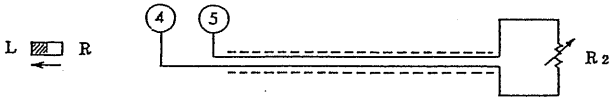

Figure 3-17

o The relationships between the output current (I_o) and the external resistance signal (R₂) can be expressed as follows:

$$I_o = \frac{I_{ref} \cdot I_{omax} \cdot b}{10 (a + R_2)}$$

where, I_{ref}: 6.5 [V]

I_{omax}: 1 A system 1 [A]

3 A system 3 [A]

a: 6.5 [kΩ]

b: 0 - 10 [kΩ]

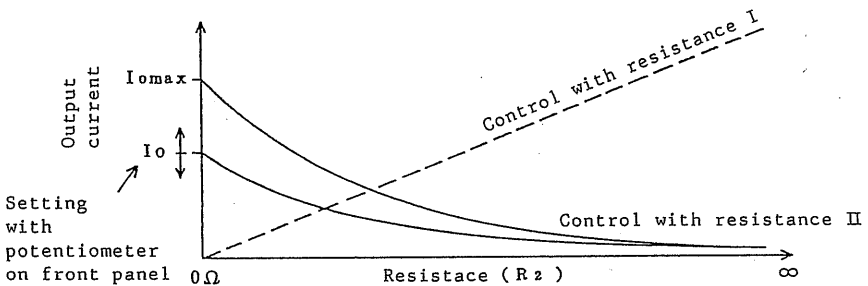

Figure 3-18

The output current (I_o) is inversely proportional to the external resistance signal (R_2) as shown in Figure 3-18. When the external resistance signal circuit is made open (the resistance has become infinite) due to switching of resistors or by inadvertent handling of the external resistance signal circuit, the output circuit is driven to the safer side (the output current becomes zero).

The output current (I_o) is determined by R_2 and b . Factor b is determined by the CURRENT setting potentiometer on the front panel.

- Note 1: For the external resistance signal (R_2), use a resistor of 1/2 W or over, with good temperature, aging and noise characteristics.
- Note 2: If the R/L which is thrown to the R (remote) position, no output will be delivered. Keep it in the L (local) position.
- Note 3: For wiring of the external resistance signal (R_2), use a shielded cable (or a pair of stranded wires) and connect the shielding wire of the cable to the "+" OUTPUT terminal. When the wiring distance is long, pay attention to prevent induction noise because such will be superimposed as ripple noise on the output.

3-4. Series or Parallel Operation

3-4-1. Series Operation

- o Two or more instruments can be connected in series to obtain a higher output voltage.

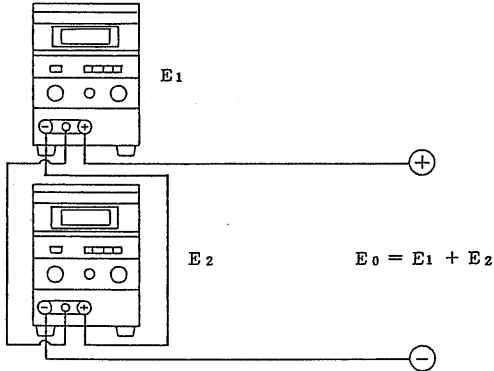

Figure 3-19

- (1) The number of instruments which can be connected in series is limited by the withstanding voltage (250 V) of the instruments with respect to the ground. (For example, when the instruments' output voltages are 32 V, up to seven units can be operated in series as $250 \div 32 = 7$ with remainder 26.
- (2) In order to eliminate potential differences among chassis of units connected in series, disconnect the GND shorting bars of the units and connect the GND terminals together to the same potential as required.

3-4-2. Parallel Operation

- o Two or more instruments can be connected in parallel to obtain a larger current.

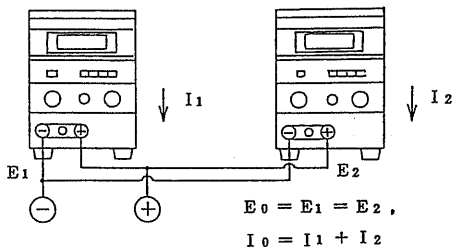

Figure 3-20

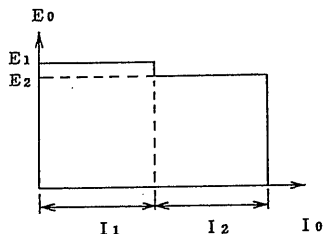

Figure 3-21

- o To operate the instruments in the constant-voltage mode, set their output voltages uniformly at the same voltage. When the parallel-connected instruments are operated in the constant-voltage mode, the current initially is fed by the unit which is set at the highest voltage and when this unit has been transferred into the constant-current domain and its output voltage is reduced, the unit of the next highest output voltage is brought into operation. Consequently, ununiformity of the output voltages is reflected into load change.
- o When operating the instruments in the constant-current mode, confirm that the CC lamps of the instrument are on. The total output current of the setup is the sum of the output currents of the individual instruments.

Note 1: Pay attention so that the output voltage of each instrument does not exceed its rated output voltage.

Note 2: To the instrument(s) the output voltage setting of which is low, a current of several milliamperes will flow in the reverse direction.

3-5. One-control Parallel Operation

- o By controlling one master unit, any number of slave units which are connected in parallel with the master unit to increase the current capacity can be controlled.

Note: Note that this operation can be done only with the same model of instruments.

* Read "Restrictions on Remote Control Operation" at the beginning of Section 3.

- o When the instruments are with standard connections (when the connections of the internal connectors D and E have not been altered), perform the following procedure starting by Step (6).

- (1) Disconnect the input power cord.
- (2) Remove the cover referring to Section 4-1-3. Remove the fixing-screws of PC board A-650.
- (3) Change the connections of connectors D and E on PC board A-650 as shown in Figure 3-2. The connectors have a lock. Do not attempt to pull out them forcefully. (See Table 3-2 and Figure 3-3.)



Figure 3-22

- (4) Carefully install the PC board and the cover.
- (5) Connect the jumper to between terminals ⑥ and ⑦ of the rear terminal block of the master unit.
- (6) Disconnect the jumpers from between terminals ⑥ and ⑦ of the slave units.

- (7) Connect terminal ⑧ of the master unit to terminal ⑦ of all slave units. (See Figure 3-23.)
- (8) Connect the output terminals of all units to the load, using wires of the same gauge and the same length. (Note that the current distribution may become ununiform unless wires of the same gauge and length are used for wiring to the "+" OUTPUT terminals or, to put it more accurately, unless the potential differences between the "+" OUTPUT terminals of the instruments and the "+" terminal of the load are uniform.)
- (9) Turn the VOLTAGE setting potentiometers of the slave units to the clockwise extreme position. Turn on the OUTPUT switches of the slave units.
- (10) For remote control operation, control the master unit.
- (11) Post the following seal (supplied) on the transparent cover above terminals ⑥ and ⑦ of each unit:

PARALLEL OP
- (12) Post the following seals on the panel or cover of the master unit: PARALLEL OPERATION MASTER

Post the following seals on each of the slave units:
 PARALLEL OPERATION SLAVE

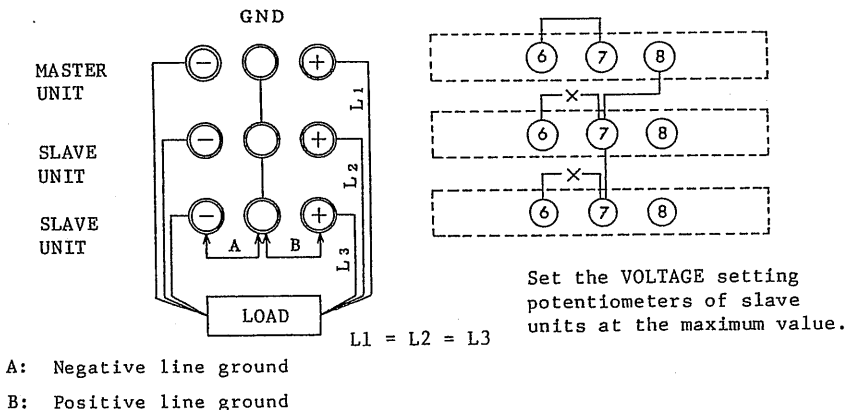

Figure 3-23. One-control parallel operation

Note 1: o The output mode is indicated by the CV/CC lamps of the master unit.

o Of the slave units, the CC lamps are constantly on.

Note 2: o Normally, ground the "+" or "-" line.

CAUTION: IF WIRING TO THE LOAD IS DISCONNECTED WHEN IN PARALLEL OPERATION, POWER SUPPLIES MAY BURN UP. ESPECIALLY SECURELY CONNECT THE WIRING TO THE LOAD WHEN IN PARALLEL OPERATION.

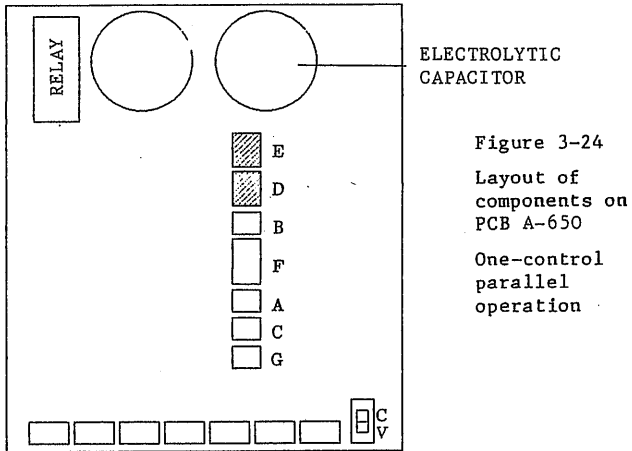
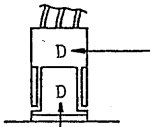

Figure 3-24
Layout of components on PCB A-650
One-control parallel operation

Table 3-2. Relationships between application functions and connectors

	ON/OFF control of output	H	D
	One-control parallel operation	D	None
Connector number on PCB		D	E

3-6. One-control Series Operation (Operation as Dual Tracking Power Supply)

- o By controlling the master unit alone of the instruments connected in series, the slave units can be controlled to increase the output voltage of the setup. (The uppermost one of the instruments connected in series operates as the master unit.)
- * There are no restrictions on the master unit, although the slave units are required to be set for the standard terminal connections.

If the slave units have already been set for the standard connections (the connections of connectors A, B and C are set as in the case of control of the output voltage with an external voltage signal and the connections have not been altered), perform the following procedure starting by Step (6).

- (1) Disconnect the input power cord.
- (2) Of the slave units only, remove the covers referring to Section 4-1-3 and remove the fixing screws of PC board A-650.
- (3) Of each slave unit, change the connections of connectors A, B and C on PC board A-650 as shown in Figure 3-25. (See Figure 3-5). Since the connectors have a lock, do not attempt to pull them out forcefully. (See Figure 3-3.)

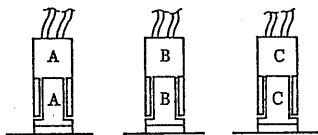
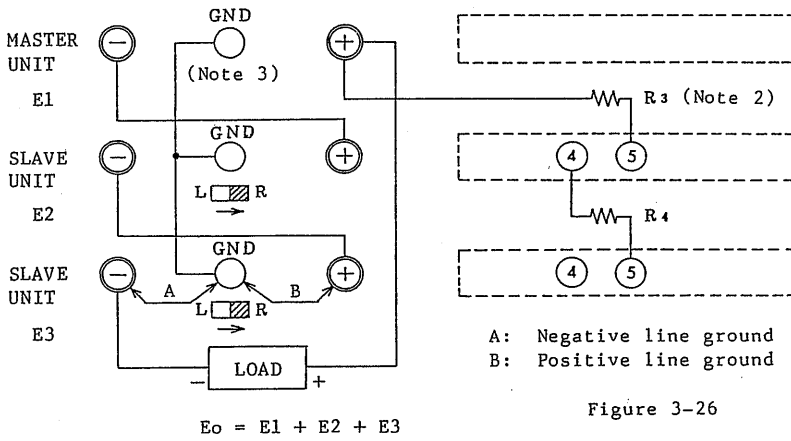

Figure 3-25

- (4) Of each slave unit, throw switch S on PC board A-650 to the white mark side. (See Figure 3-5.)
- (5) Carefully install the PC board and cover.

- (6) As shown in Figure 3-26, connect in series the output terminals of the units. Connect resistor R3 between the "+" OUTPUT terminal of the uppermost unit (master unit) and terminal ⑤ of slave unit 1 which is located next to the master unit. Connect resistor R4 between terminal ④ of slave unit 1 and terminal ⑤ of slave unit 2.
- (7) Of each slave unit, throw the R/L switch on the front panel to the R (remote) position.
- (8) Of each slave unit, turn the VOLTAGE and CURRENT setting potentiometers to the clockwise extreme positions. Remove the knobs of both COARSE and FINE VOLTAGE setting potentiometers and install the guard caps. (See Item (10) of Section 2-1.)
- (9) Connect in common the GND terminals of all units and connect the common line to the required potential line.
- (10) Turn on the POWER switches and OUTPUT switches of the slave units. Turn on the POWER switch and OUTPUT switch of the master unit.
 - o For remote control operation, control the master unit only.
 - o When the instruments are operated in the constant-voltage mode, the CV lamps (green) of the master and slave units turn on.
 - o Setting of limiting current must be set not only for the master unit but for all of the slave units also.



o Calculation of resistance R3 (R4)

$$R_3 \cong \left(\frac{E_1}{E_2} \times A \right) - 10 \text{ [k}\Omega\text{]}$$

where, $R_3 \geq 0$ or $E_2 \leq \frac{A}{10} \times E_1$

R3 (R4): Externally connected resistor [kΩ]

E1: Output voltage of master unit [V]

E2: Output voltage of slave unit 1 [V]

E3: Output voltage of slave unit 2 [V]

For calculation of R4, substitute as follows in the above formula: E1 = E2, E2 = E3, and R3 = R4.

Table 3-3

Rated voltage	18 V system	32 V system	70 V	110 V	250 V	350 V
Constant A	18	32	70	110	250	350

o To adjust the output voltage, adjust the VOLTAGE setting potentiometers of the slave units.

- o For resistor R3 (R4), use a resistor of 1/2 W or over, with good temperature, aging and noise characteristics. The resistor should also have a sufficiently high dielectric strength since the output voltage of the master unit is applied to the resistor.

Note 1: The number of units which can be connected in series is restricted by the withstanding voltage (250 V) of the instruments with respect to ground. (For example, when the output voltages of the instruments are 32 V, up to seven units can be connected in series because $250 \div 32 = 7$ and remainder 26.)

Note 2: Install resistor R3 (R4) near terminal (5).

Note 3: In order to prevent potential differences among chassis of units, connect together the GND terminals of all units and connect it to a line of the required potential.

- o With two units (master unit and slave unit), a positive/negative tracking power supply setup can be obtained.
- o Post the following seals (supplied) on the units.

Master unit: SERIES OPERATION MASTER

Slave units: SERIES OPERATION SLAVE

3-7. External Battery Drive of Digital Meter

- o The digital meter can be driven with an external battery power source (two dry cells).
- (1) Disconnect the input power cord.
 - (2) Remove the cover referring to Section 4-1-3.
 - (3) Throw switches SW2 and SW3 on PCB board A-681 to the white mark positions as shown in Figure 3-27. Install the cover.
 - (4) Connect two 1.5V manganese dry cells to terminals ①, ② and ③ of the rear terminal block, in the correct polarity as shown in Figure 3-28.

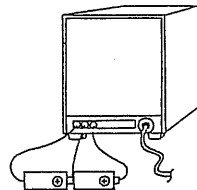
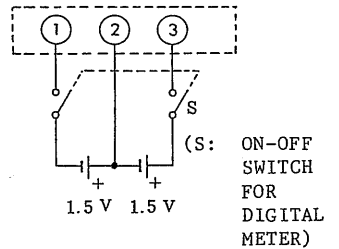
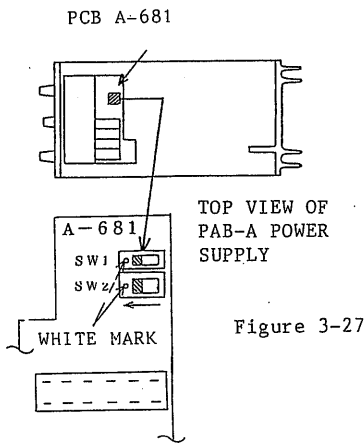

- o The supply voltage for the digital meter is $\pm 1.5 \text{ V} \pm 15\%$, with terminal ② as the common line.
- o When the supply voltage has fallen to $\pm 1.2 \text{ V}$ to $\pm 1.4 \text{ V}$, a battery mark () is displayed at lower left on the liquid crystal display. The battery mark means that the dry cells should be replaced. (When a regular type of manganese dry cells are used,

indication of the battery mark does not immediately mean that the digital meter will become malfunctioning.)

- o The power consumption of the digital meter is 5 mW (typical). Two SUM-3 dry cells will serve approximately 20 days.

SECTION 4. MAINTENANCE

4-1. Inspection

- o Inspect the instrument at regular intervals so that it maintains its initial performance for a long time.

4-1-1. Removing Dust and Dirt

- o When the panels have become dirty, wipe them lightly with a cloth moistened with neutral soapsuds and then wipe them with a clean, dry cloth.
- o Do not use benzine, thinner, or other chemical detergent.

4-1-2. Inspection of Input Power Cord

- o Check the input power cord for damage of the vinyl cover and overheating of the plug and cord stopper. Check the terminal screws and binding posts for loosening.

4-1-3. Removing and Installing the Cover

- (1) Be sure to disconnect the input power cord before starting removing the cover, for the sake of safety. (If the instrument power has been on, allow a discharge time of approximately 2 minutes after turning off the POWER switch and then proceed to the next step.)
- (2) Remove four screws (M3-6L) and one screw (M3-4L). Remove the screw by pulling it upward. (Be careful not to misplace the screws removed.)

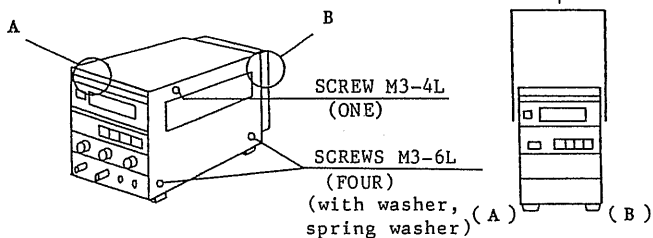

Figure 4-1

- (3) When installing the cover, exercise care so that the top of the panel and the right and left sides of the heat sink are set in the guides of the cover.

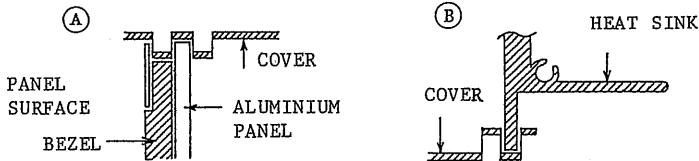

Figure 4-2

Note: Do not use other screws than the specified ones, lest the wiring should be damaged.

4-1-4. Cleaning of Inside

Remove dust from the inside of the casing and ventilation holes of the cover by using a compressed air or the exhaust air of a vacuum cleaner.

4-1-5. Removing the PC Board

Remove the three fixing-screws (M3-6L) and open the cover.

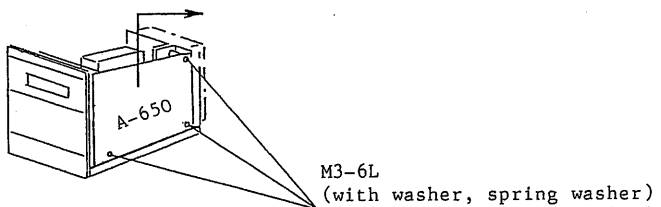

Figure 4-3

EXERCISE CARE SO THAT THE TOP OF PC BOARD A-650 DOES NOT HIT THE CHASSIS.

4-1-6. Inspection of Fuses

- (1) Input fuse:
 - o Slow blow (time lag) type fuse
 - o Supplied as an accessory
- (2) Output fuse:
 - o Regular type fuse
 - o The PAB350-0.1A has no output fuse.

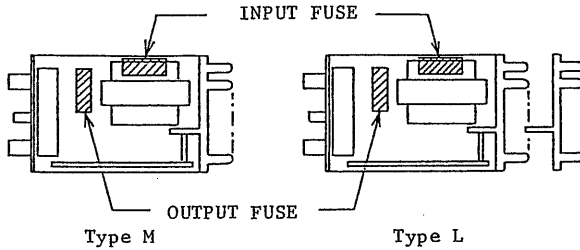

Figure 4-4

Table 4-1

Model	PAB 18-1A	PAB 18-1.8A	PAB 18-3A	PAB 32-1.2A	PAB 32-2A
Input fuse	1.5 A SB	2 A SB	3 A SB	2 A SB	3 A SB
Output fuse	1.5 A	2 A	4 A	1.5 A	2.5 A

Model	PAB 70-1A	PAB 110-0.6A	PAB 250-0.25A	PAB 350-0.1A
Input fuse	3 A SB	3 A SB	3 A SB	2 A SB
Output fuse	1.5 A	1 A	0.3 A	None

External dimensions of fuse: 6.4 mm dia., 31.8 mm long

4-2. Adjustment and Meter Calibration

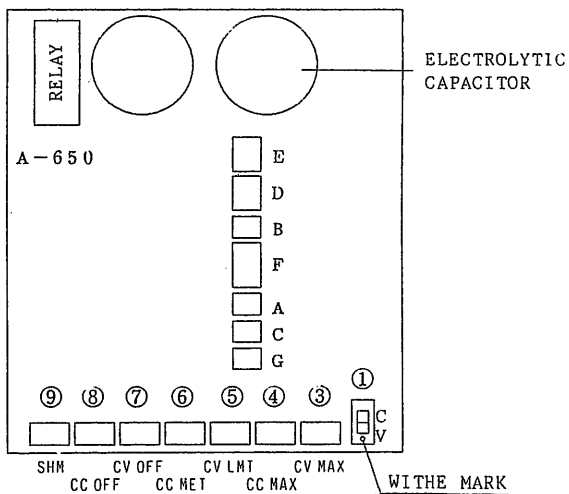

Figure 4-5. Layout of components of PC board A-650

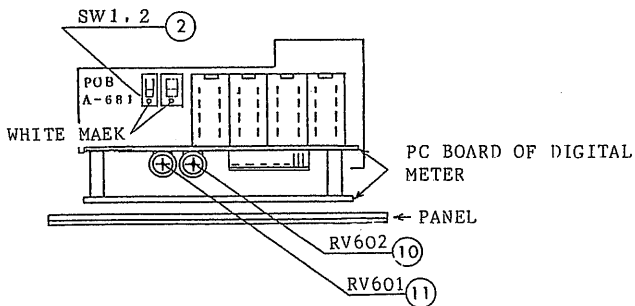

Figure 4-6. Layout of components on top of panel

- ① Voltage/current selector switch
- ② Power source selector switch for digital meter
- ③ Maximum voltage adjustment potentiometer

- ④ Maximum current adjustment potentiometer
- ⑤ Voltage calibration potentiometer for voltage setting
- ⑥ Ammeter calibration potentiometer
- ⑦ Output voltage offset adjustment potentiometer
- ⑧ Ammeter zero-adjustment potentiometer
- ⑨ Relay select voltage adjustment potentiometer
- ⑩ Digital meter reference voltage calibrator
- ⑪ Digital meter full-scale calibrator

4-2-1. Relationships Between Application Functions and Connectors or Switches

Table 4-2

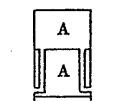

Housing section	Control of output voltage with external voltage signal	A	B	C	*	*	*	o	*
	Control of output current with external voltage signal	A	B	C	*	*	*	●	*
	Control of output voltage with external resistance signal I	C	B	A	*	*	*	*	*
	Control of output voltage with external resistance signal II	A	B	G	*	C	*	o	*
	Control of output current with external resistance signal I	A	C	B	*	*	*	*	*
	Control of output current with external resistance signal II	A	B	G	*	C	*	●	*
	ON/OFF control of output	*	*	*	H	*	D	*	*
	One-control parallel operation	*	*	*	D	*	-	*	*
	Driving of digital meter with external battery power source	*	*	*	*	*	*	*	o
Connector numbers on PC board	A	B	C	D	G	E	S1	S2 S3	

o: White mark side ●: No mark side *: Not specified

4-2-2. Calibration of Digital Meter

- o To calibrate the digital meter as may be required by aging or other cause, proceed as described in this section.

(A) For models whose rated voltage is 110 V or lower

- (1) Press the EXT button (external voltage measurement switch) and apply a voltage of 190.0 mVDC (*1) between the HIGH and LOW terminals. Adjust potentiometer RV602 (⓪ in Figure 4-6) so that the meter reads 190.0 \pm 1 digits, at ambient temperature 23°C \pm 1°C (73.4°F \pm 1.8°F).
- (2) Apply a voltage of 1.900 V (*1) between the HIGH and LOW terminals. Adjust potentiometer RV601 (⓪ in Figure 4-6) so that the meter reads 1.900 \pm 1 digits, at ambient temperature 23°C \pm 1°C (73.4°F \pm 1.8°F).

Change the voltage to 19.00 V and 190.0 V and check the operation at the 20V and 200V ranges. If deviations are large, adjust them toward the center.

(*1: Accuracy 0.05% or better)

(B) For Models PAB250-0.25A and PAB350-0.1A

- (1) Turn the VOLTAGE setting control to the counterclockwise extreme position so that the output voltage becomes approximately zero volts. Apply a voltage of 190.0 mV (*1) with respect to the "-" terminal as a ground. Adjust potentiometer RV602 (⓪ in Figure 4-6) so that the meter reads 190.0 \pm 1 digits, at ambient temperature 23°C \pm 1°C (73.4°F \pm 1.8°F).
- (2) Apply a voltage of 1.900 V (*1) between the output terminals. Adjust potentiometer RV601 (⓪ in Figure 4-6) so that the meter reads 1.900 \pm 1 digits, at ambient temperature 23°C \pm 1°C.

Make open the output terminals and connect a voltmeter (*1) to them. With output voltages 19.00 V and 190.0 V, check

the operation at the 20V and 200V ranges. If deviations are large, adjust them toward the center.

(*1: Accuracy 0.05% or better)

NOTE: When performing the procedure of 1, be sure to turn the output VOLTAGE setting knob to the counterclockwise extreme position. When setting the output voltage to 19.00V or 190.0 V in the procedure of 2, connect the voltmeter alone to the output terminals.

4-2-3. Calibration of Preset Voltage Indication

- o This procedure is to calibrate the preset voltage indication by the digital meter when the OUTPUT switch is turned off.
- (1) Turn off the OUTPUT switch. Adjust the output voltage as shown in the following table.

<u>Rated Voltage</u>	<u>Output Voltage</u>
18 V Type	10 mV - 20 mV
32 V Type	10 mV - 20 mV
70 V	10 mV - 100 mV
110 V	100 mV - 300 mV
250 V	100 mV - 300 mV
350 V	100 mV - 300 mV

- (2) Turn on the OUTPUT switch. Adjust the CV OFF potentiometer (⑦ in Figure 4-5) so that the digital meter indicates the same value.

NOTE: The measuring unit is changed to mV or V as the switch is turned ON or OFF, respectively.

- (3) For the models whose rated output voltages are 110 V or lower, turn on the OUTPUT switch and set the output voltage at 17.50 V. For the models whose rated output voltages are 250 V or higher, set the output voltage at 175.0 V.

- (4) Turn off the output switch. Adjust the CV LMT potentiometer (⑤ in Figure 4-5) so that the digital meter indicates the same value.

4-2-4. Calibration of Ammeter

- (1) Press the A (ammeter) switch and turn off the OUTPUT switch.
- (2) Adjust the CC OFF potentiometer (⑧ in Figure 4-5) so that the digital meter reads 0 A (zero amperes).
- (3) Connect an ammeter (or a shunt resistor) of an accuracy of 0.2% or better to the output terminal and feed the current (I1) shown in Table 4-3.
- (4) After feeding the current for approximately 20 minutes, adjust the CC MET potentiometer so that the meter indicates the value of output current I1.

4-2-5. Adjustment of Maximum Variable Constant-voltage Range

- (1) Press the V (voltmeter) switch and turn on the OUTPUT switch.
- (2) Turn both COARSE and *FINE VOLTAGE setting potentiometers to the clockwise extrem position. Adjust the CV MAX potentiometer (③ in Figure 4-5) so that the output voltage becomes E_0 (maximum voltage) shown in Table 4-3. (*: The PAB110-0.6A, PAB250-0.25A and PAB350-0.1A have no FINE VOLTAGE setting potentiometer.)

4-2-6. Adjustment of Maximum Variable Constant-current Range

- (1) Connect an ammeter of an accuracy level of approximately 0.5% to the output terminal.

- (2) Turn the COARSE CURRENT setting potentiometer (including the FINE CURRENT setting potentiometer if the FINE VOLTAGE potentiometer has been modified to it) to the clockwise extreme position. Adjust the CC MAX potentiometer ((4) in Figure 4-5) so that the output current becomes I_0 (maximum current) shown in Table 4-3. (The PAB110-0.6A, PAB250-0.25A and PAB350-0.1A have no FINE setting potentiometer.)

4-2-7. Adjustment of Relay Switching Circuit

- o Preparation: Adjust the input power line voltage to the rated voltage (100 V) and operate the instrument in the no-load state.
- o Voltage adjustment of the Schmitt trigger circuit for switching of main transformer taps
 - (1) Press the V (voltmeter) switch and turn on the OUTPUT switch.
 - (2) Increasing gradually the output voltage, adjust the SHM potentiometer ((9) in Figure 4-5) so that the relay trips at the voltage of E_1 shown in Table 4-3.

Note: The circuit has hysteresis. Once the relay has tripped (has become on), lower the output voltage to reset (to turn off) the relay.

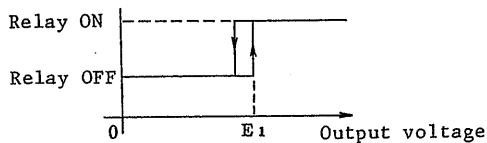

Table 4-3

Model Adjustment	PAB 18-1A	PAB 18-1.8A	PAB 18-3A	PAB 32-1.2A	PAB 32-2A
Ammeter calibration: I1	1.0 A	1.8 A	3.0 A	1.2 A	2.0 A
Adjustment of maximum variable constant- voltage range: Eo (max)	19 V	19 A	19 V	33.6 V	33.6 V
Adjustment of maximum variable constant- current range: Io (max)	1.05 A	1.90 A	3.15 A	1.26 A	2.10 A
Adjustment of relay switching circuit E1	8.0 V	7.5 V	8.5 V	20.5 V	20.5 V

Model Adjustment	PAB 70-1A	PAB 110-0.6A	PAB 250-0.25A	PAB 350-0.1A
Ammeter calibration: I1	1.0 A	0.6 A	0.25 A	0.1 A
Adjustment of maximum variable constant- voltage range: Eo (max)	73.5 V	115 V	260 V	360 V
Adjustment of maximum variable constant- current range: Io (max)	1.05 A	0.63 A	0.26 A	0.105 A
Adjustment of relay switching circuit E1	44.5 V	67 V	150 V	189 V

PAB-A SERIES CIRCUIT DIAGRAMS

MODEL	DRAWING NO.				
PAB 18-1A	320178	320180	320181	320184	320185
PAB 18-1.8A	320178	320180	320181	320184	320185
PAB 18-3A	320178	320180	320181	320184	320185
PAB 32-1.2A	320178	320180	320181	320184	320185
PAB 32-2A	320178	320180	320181	320184	320185
PAB 70-1A	320178	320180	320181	320184	320185
PAB 110-0.6A	320177	320180	320182	320184	320185
PAB 250-0.25A	320177	320180	320182	320184	320185
PAB 350-0.1A	320179	320180	320183	320184	320185

NOTES

1. UNLESS OTHERWISE SPECIFIED RESISTOR VALUES ARE IN OHMS.
2. UNLESS OTHERWISE SPECIFIED ALL RESISTORS ARE 1/4 WATT, $\pm 5\%$.
3. UNLESS OTHERWISE SPECIFIED CAPACITOR VALUES ARE IN MICRO FARADS.

*1 : 10-TURN POTENTIOMETER

*2 : TIME RUG TYPE FUSE (S.B)

*3 : METAL OXIDE RESISTOR

*4 : WIRE WOUND RESISTOR 10%

□ : METAL FILM RESISTOR 1/4 WATT, 1%, 100PPM/°C

△ : METAL FILM RESISTOR 1/4 WATT, 1%, 50PPM/°C